









SPECIFICATIONS	
DRY WEIGHT:	3350 LBS.
TOTAL WEIGHT:	23617 LBS.
WATER VOLUME:	2431 GAL.
WATER VOLUME:	325 Cu.Ft.
WEIGHT:	20267 LBS.
SURFACE AREA:	121 SQ. FT.
IAPMO#:	1138
FDA#:	2030305

SKID SUPPORT STRUCTURE* BONDED TO SPA
 *SKIDS SUPPLIED BY NESPA
LIGHT NICHE
 SPA BRIGHT, 120 V, 100 WATT, 50 CORD, U.L. APPROVED
SKIMMER
 HAYWARD SP-1084PVE SURFACE SKIMMER W/ EQUALIZER, NSF APPROVED
MAIN DRAIN
 AquaStar 32CDFLFR, 32" Channel Drain, Approved Max Flow Rate: Floor = 236 GPM @ 3.4'ps Wall = 136 GPM @ 1.9'ps V.G.B Approved Safety Drain
SIDEWALL SUCTION
 Paramount SDX 10" HIGH FLOW SAFETY DRAIN Area of Opening = 43.201 in ² Velocity @ 200 GPM = 1.486 fps V.G.B Approved Safety Drain
JET
 HYDRO INLETS 1-1/2" WATER - 1-1/2" AIR HYDROAIR #10-350 COMPLIES W/ ANSI CODE ASME A112.19.8-07 U.L. APPROVED
RETURN
 INLET FITTINGS 1-1/2" WALL TYPE W/ EYEBALL HYDROAIR #10-350 COMPLIES W/ ANSI CODE ASME A112.19.8-07 U.L. APPROVED
FILL
 INLET FITTINGS 1-1/2" WALL TYPE W/ EYEBALL HYDROAIR #10-350 COMPLIES W/ ANSI CODE ASME A112.19.8-07 U.L. APPROVED

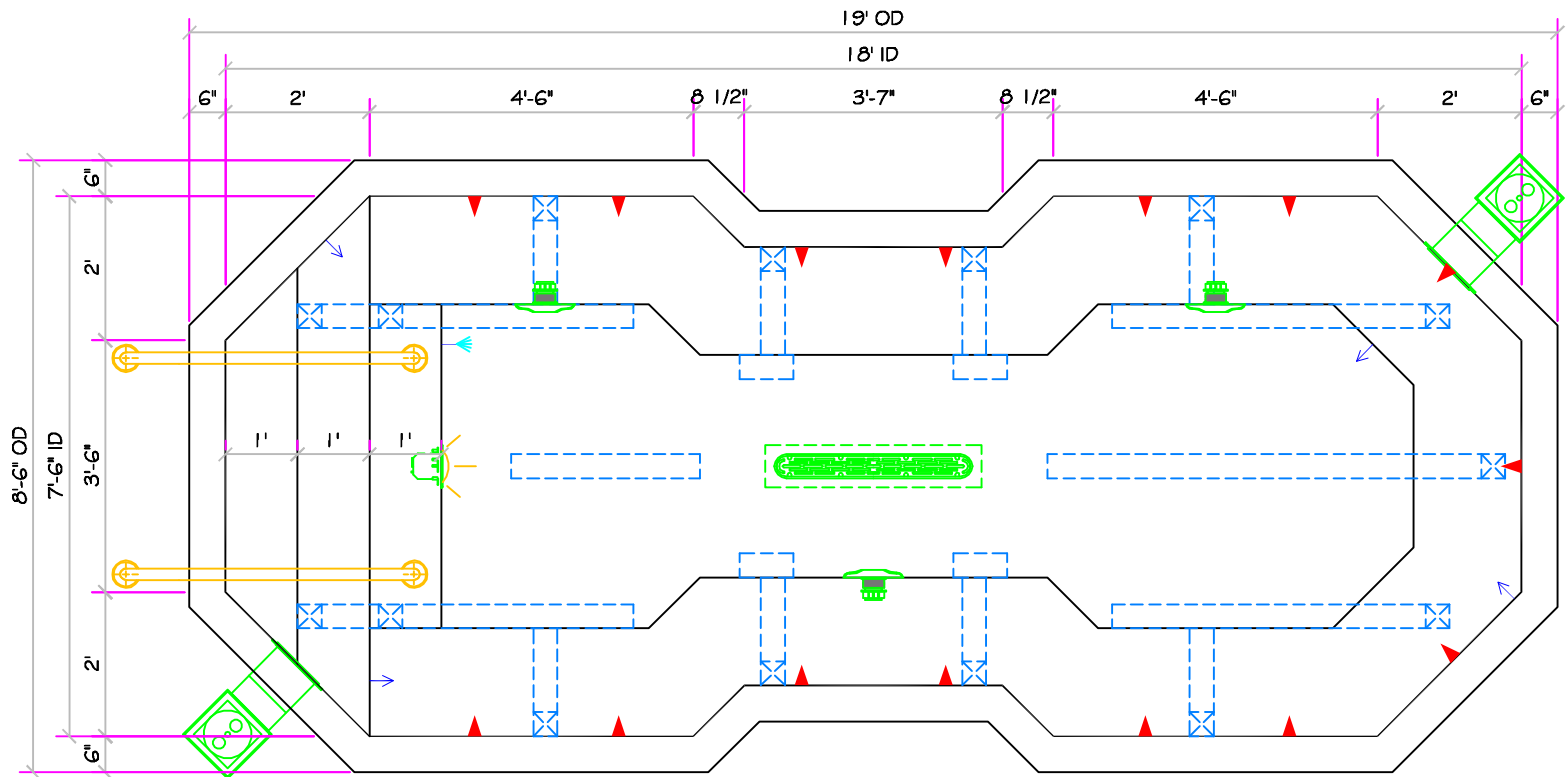

**18' RENAISSANCE
(SWIM SPA)
ALL TILED SPA - Fits 12 Adults**

*** Complies with V.G.B.
Pool and Spa Safety Act
APPROVED FOR
COMMERCIAL USE**

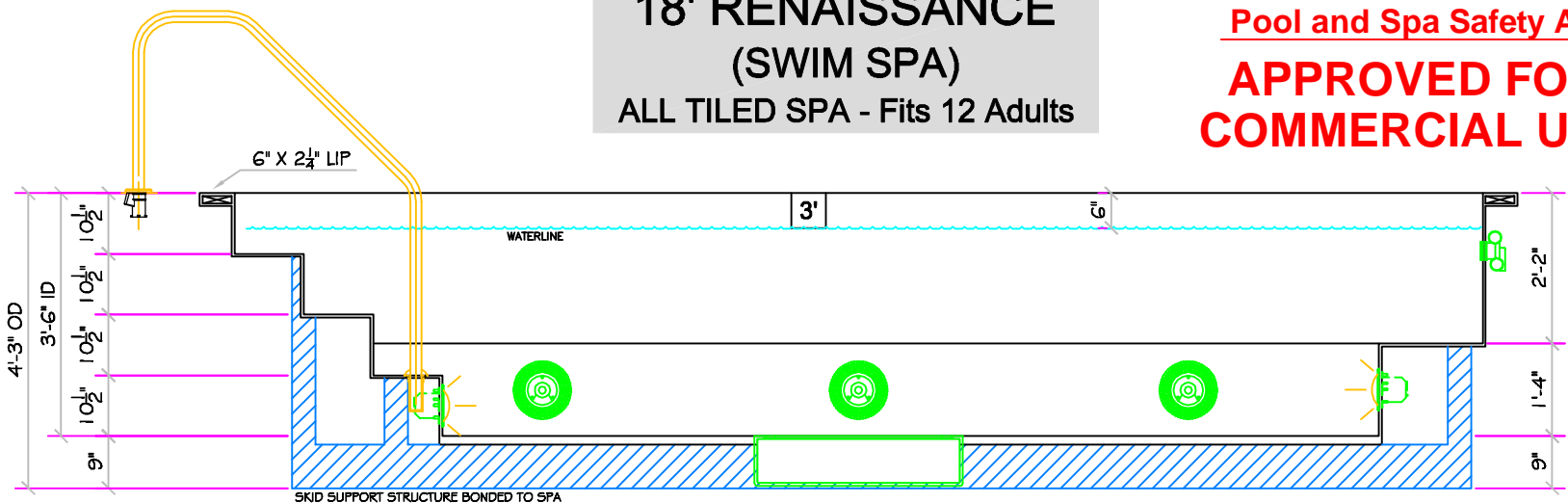

ALL DIMENSIONS SUBJECT TO 1/4" TOLERANCES

Feb 03, 2009 - 4:15pm

These drawings, concepts, and details contained herein are the original proprietary designs of NESPA ENTERPRISES, developed over many years of experience in the pool and spa industry and as such are protected by the copyright laws of the United States Government. Reproduction of any of the above without written permission to do so by NESPA ENTERPRISES, is illegal.

NESPA ENTERPRISES INC.
 2800 Richter Ave. Ste. C Oroville, CA 95966
 Office: (530) 534-9910 Fax: (530) 534-9915
 E-Mail: sales@tiledspas.com Web Site: www.tiledspas.com



SIZE A	DWG NAME NESPA_MASTER_MODELS	DWG TYPE SD (LA)
SCALE 3/8" = 1'	DATE 2/3/2009	SHEET PAGE 1 OF 1