

PLAN APPROVAL DOCUMENTATION

DRAWING REVISION HISTORY

APPROVED

SHEET 1 - SD-All (Basic Spa Detail)

REV NOTE:

SHEET 2 - Tile Detail

REV NOTE:

SHEET 3 - SUCTION Plumbing

REV NOTE:

SHEET 4 - RETURN Plumbing

REV NOTE:

SHEET 5 - Air Channel

SHEET 6 - Rail Detail

SHEET 7-10 - Women's Spa Layouts

SHEET 11-14 - Men's Spa Layouts

SHEET 15-17 - RENDERS

I approve the above drawings _____ Date: _____

Any changes to these plans from here forward shall be directed in writing to Nespa.

SPA FABRICATION AUTHORIZATION

Nespa's engineering and structural manufacturing departments may find it necessary to make slight adjustments (= 1") to your spa. This may include the size of the spa (OD/ID), tile cuts, depths, jet location, bench steps etc. These adjustments must be made in the primary stages of building the spa. The adjustments are generally made to ad structural and aesthetic integrity to the vessel. IE: balance of supporting gussets (exterior) and less tile cuts/ symmetrical cuts, grout lines, etc. (interior)

Please initial next to the following number that describes your project needs .

- _____ 1. YES, I understand adjustments need to be made. Nespa will use their expertise to make these adjustments as needed. I give them the authority to make changes. I will receive final accurate drawings prior to receipt of spa or spa hole construction (if changes were made to the size)
- _____ 2. NO, No changes can be made even under 1". Dimensions are fixed. More tile cuts may be needed, Structural supports may be altered to accommodate.
- _____ 3. Nespa will need to contact us for any changes to spa dimensions prior to continued spa fabrication.

SPAS BY RENEE
6280 PECOS ROAD STE. 600
LAS VEGAS, NV 89120
Office: (702) 458-8862 Fax: (702) 458-2315



If printing as a PDF:

Page Scaling:

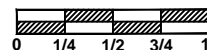

DWG TYPE
Revisions

DWG NAME
FLAMINGO HILTON

DATE
1/14/2011

SHEET
Cover Sheet

SPECIFICATIONS	
DRY WEIGHT:	2250 LBS.
TOTAL WEIGHT:	8919 LBS.
WATER:	800 GAL.
VOLUME:	107 Cu.Ft.
WEIGHT:	6669 LBS.
SURFACE AREA:	44 SQ. FT.
IAPMO#:	1138
FDA#:	2030305

SKID SUPPORT STRUCTURE* BONDED TO SPA

☒ 

*SKIDS SUPPLIED BY NESPA

LIGHT NICHE

 SPA BRIGHT, 120 V, 100 WATT, 50' CORD, U.L. APPROVED

MAIN DRAIN

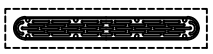

AquaStar 32CDFLFR, 32" Channel Drain, Approved Max Flow Rate: Floor = 236 GPM @ 3.4 fps Wall = 136 GPM @ 1.9 fps V.G.B Approved Safety Drain

SIDEWALL SUCTION

 Waterway SPC-3V 5" Super Hi-Flow Suction, Total Open Area = 9.02 sq in Approved Max Flow Rate: Wall = 180 GPM @ 6.42 fps V.G.B Approved Safety Drain

SKIMMER

 HAYWARD SP-1084FVE SURFACE SKIMMER W/ EQUALIZER, NSF APPROVED

JET

 WATERWAY Swim Jet 1-1/2" WATER - 1" AIR WaterWay #210-4750 COMPLIES W/ ANSI CODE ASME A112.19.8-07 UL APPROVED

RETURN

 INLET FITTINGS 1-1/2" WALL TYPE W/ EYEBALL HYDROAIR #10-3500 COMPLIES W/ ANSI CODE ASME A112.19.8-07 UL APPROVED

FILL

 INLET FITTINGS 1-1/2" WALL TYPE W/ EYEBALL HYDROAIR #10-3500 COMPLIES W/ ANSI CODE ASME A112.19.8-07 UL APPROVED

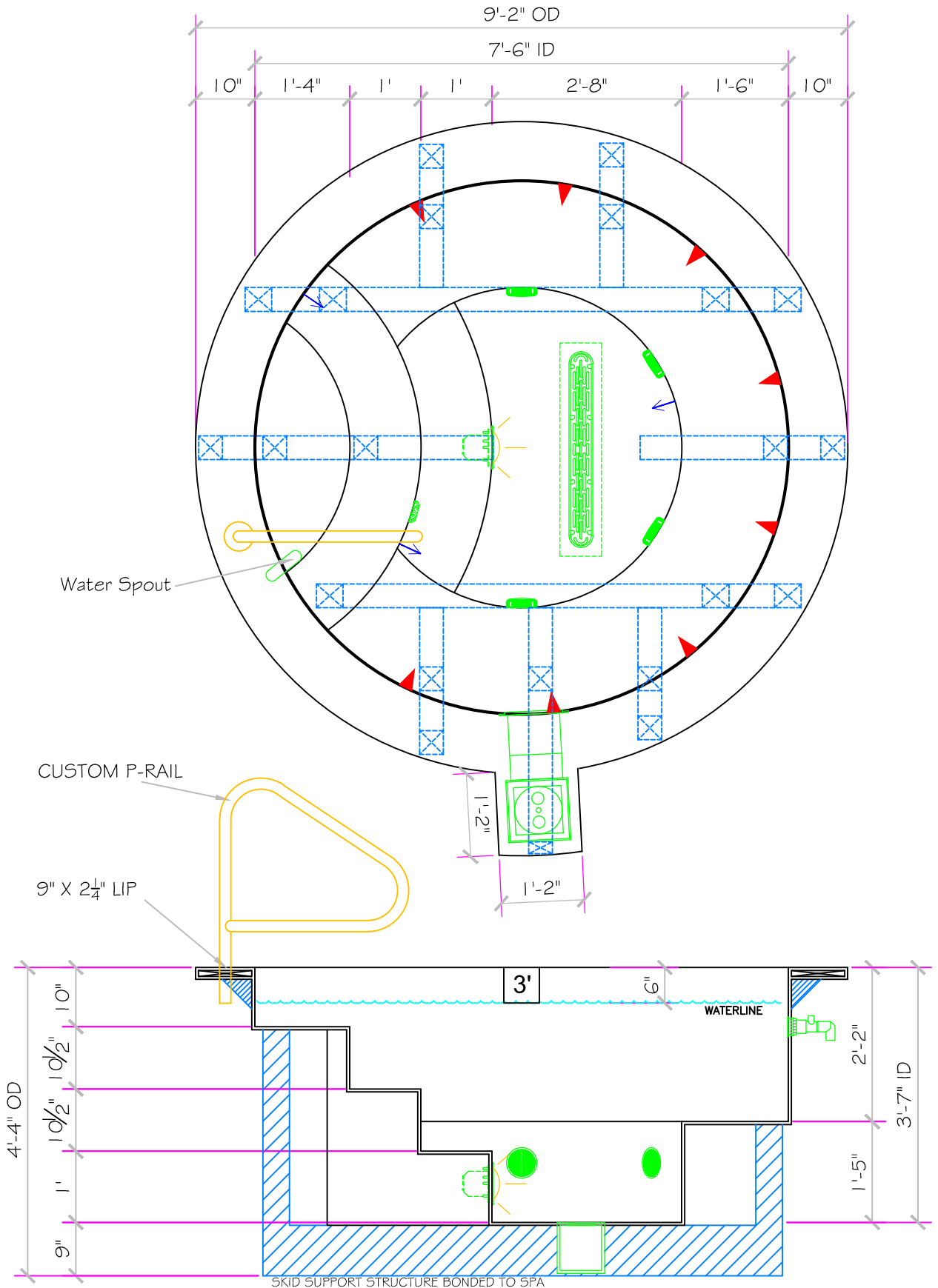

APPROVED

ALL DIMENSIONS SUBJECT TO 1/4" TOLERANCES

SPAS BY RENEE
 6280 PECOS ROAD STE. 600
 LAS VEGAS, NV 89120
 Office: (702) 458-8862 Fax: (702) 458-2315



If printing as a PDF:

Page Scaling:

SCALE
 1/2" = 1'

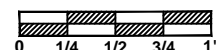

DWG TYPE
 Model

DWG NAME
 FLAMINGO HILTON

DATE
 1/14/2011

SHEET
 PAGE 1 OF 17

These drawings, concepts, and details contained herein are the original proprietary designs of SPAS BY RENEE, developed over many years of experience in the industry and as such are protected by the copyright laws of the United States Government. Reproduction of any of the above without written permission to do so by SPAS BY RENEE, is illegal.

- #1 - FIELD TILE: DAL TILE 2 X 2 - D317 Biscuit
- #2 - WATERLINE (optional): See Detail Below
- #3 - BENCH & STEP EDGES (optional): DAL TILE 2 X 2 - D195 Oak Moss
- #4 - TILED LIP (optional): DAL TILE 2 X 2 - D317 Biscuit

Date: _____
 Approval: _____

#1 - GROUT: _____
 #2 - GROUT: _____
 #3 - GROUT: _____

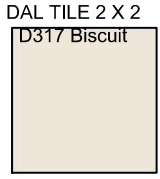

**WATERLINE
DETAIL**

CEPAC TILE - Spectrum
SPT-6 1 X 1 Green/Blue

CEPAC TILE - Renaissance
RSC-751 3 X 3 Antique Marine

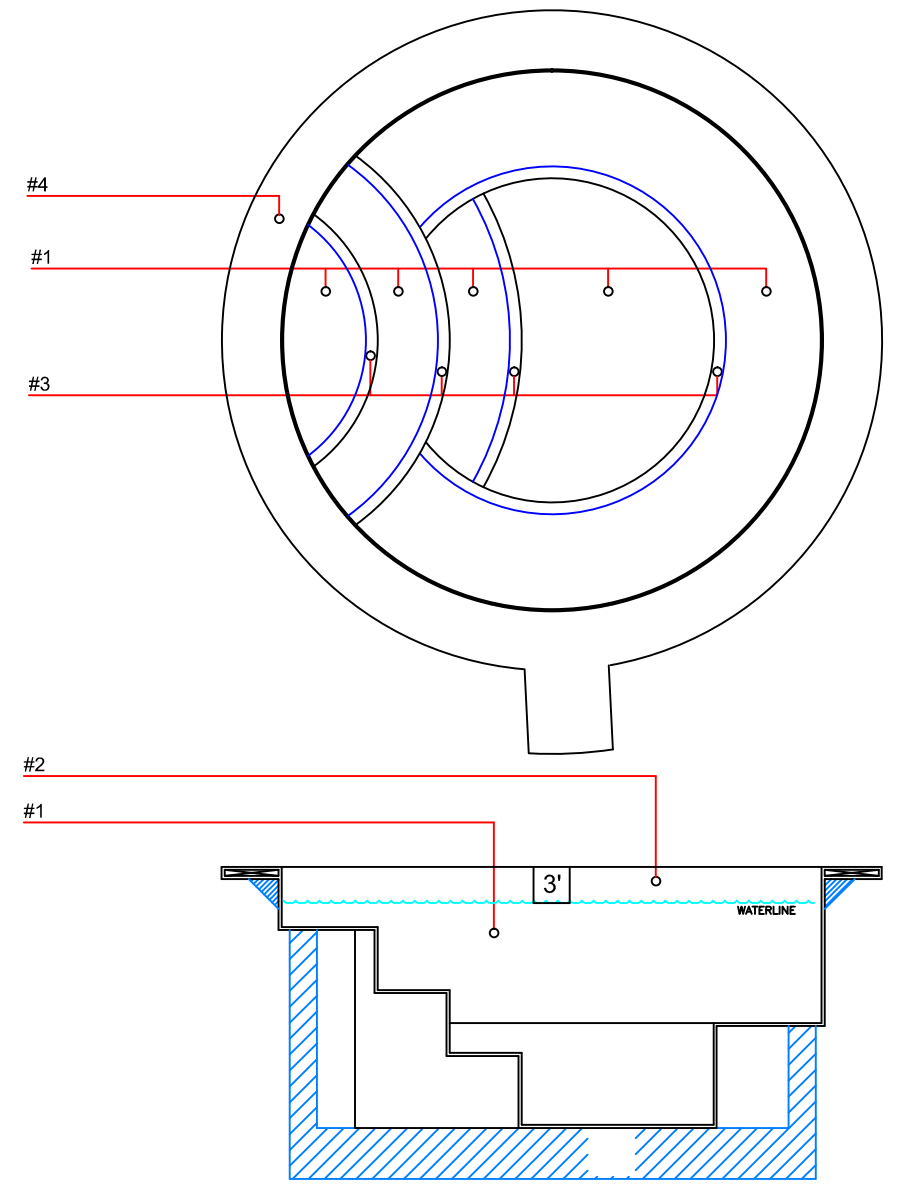

APPROVED

ALL DIMENSIONS SUBJECT TO 1/4" TOLERANCES

These drawings, concepts, and details contained herein are the original proprietary designs of SPAS BY RENEE, developed over many years of experience in the industry and as such are protected by the copyright laws of the United States Government. Reproduction of any of the above without written permission to do so by SPAS BY RENEE, is illegal.

SPAS BY RENEE
6280 PECOS ROAD STE. 600
LAS VEGAS, NV 89120
Office: (702) 458-8862 Fax: (702) 458-2315



If printing as a PDF:
 Page Scaling:

SCALE
 3/8" = 1'

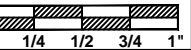

DWG NAME
 FLAMINGO HILTON

DATE
 12/16/2010

DWG TYPE
 Tile Detail
 SHEET
 PAGE 2 OF 17

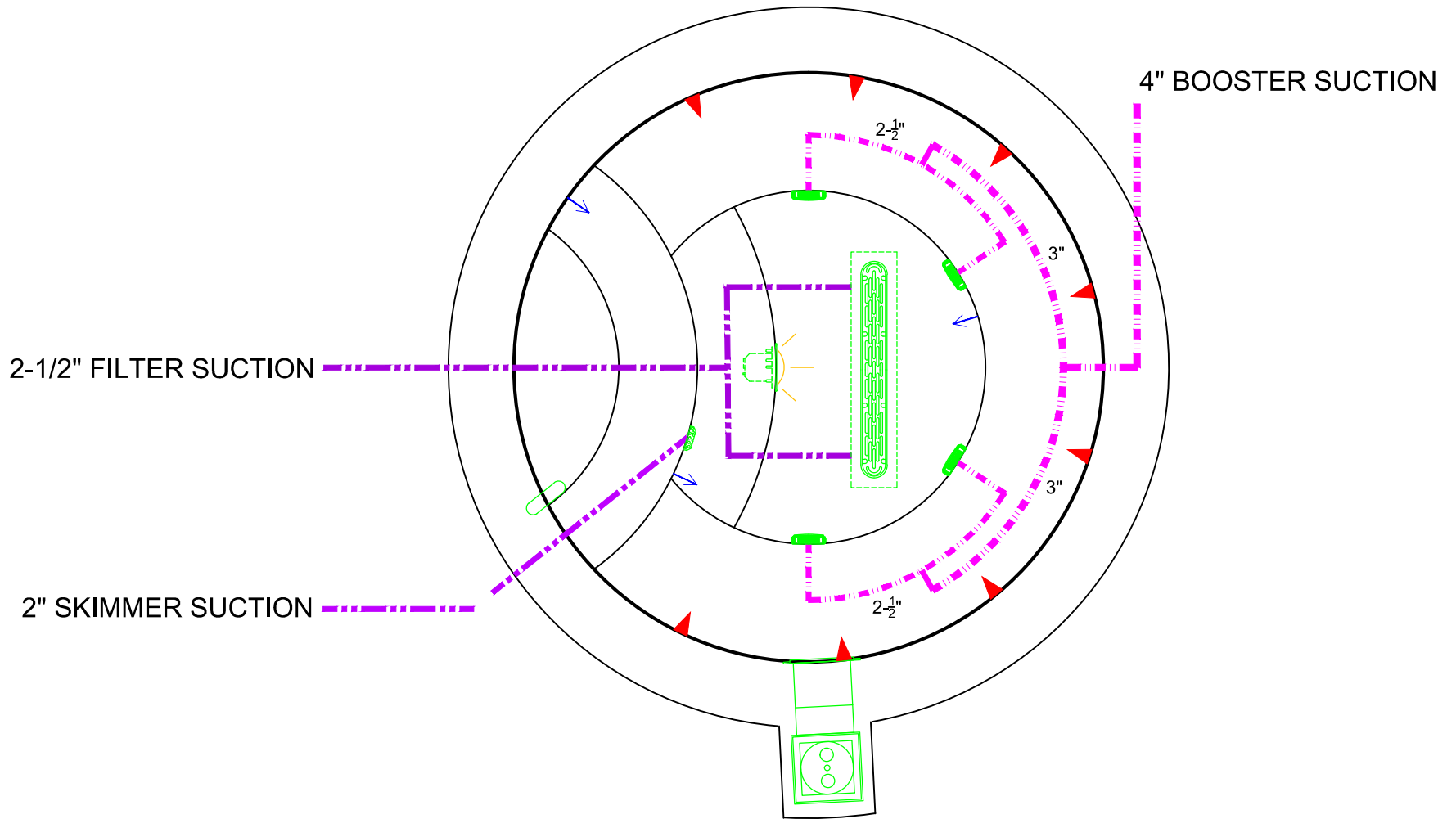

APPROVED

ALL DIMENSIONS SUBJECT TO 1/4" TOLERANCES

These drawings, concepts, and details contained herein are the original proprietary designs of SPAS BY RENEE, developed over many years of experience in the industry and as such are protected by the copyright laws of the United States Government. Reproduction of any of the above without written permission to do so by SPAS BY RENEE, is illegal.

SPAS BY RENEE
6280 PECOS ROAD STE. 600
LAS VEGAS, NV 89120
Office: (702) 458-8862 Fax: (702) 458-2315



If printing as a PDF:

Page Scaling:

DWG NAME

FLAMINGO HILTON

SCALE
 1/2" = 1'

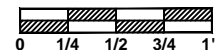

DATE
 12/16/2010

DWG TYPE
 SUCTION Plumbing

SHEET
 PAGE 3 OF 17

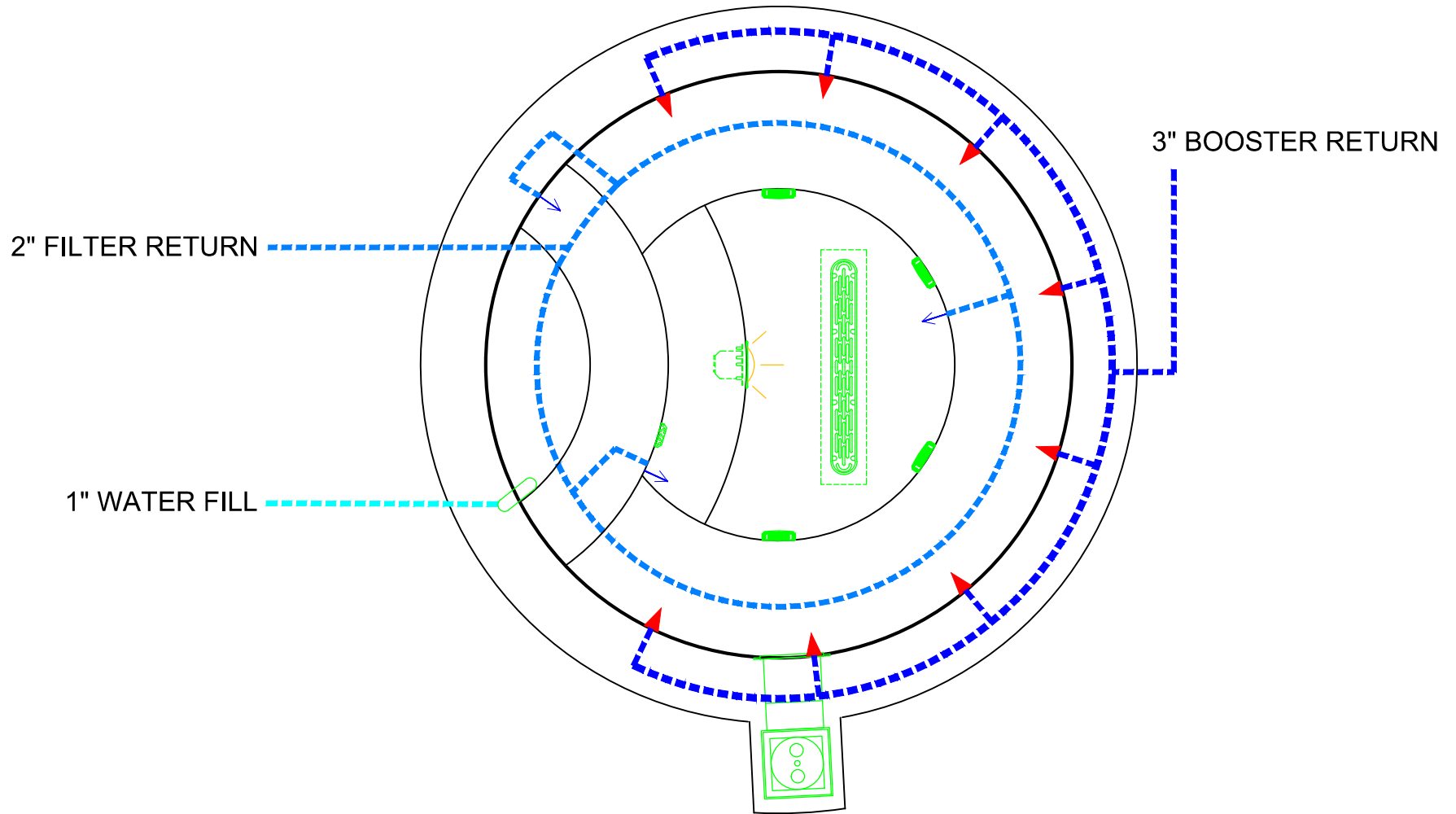

APPROVED

ALL DIMENSIONS SUBJECT TO 1/4" TOLERANCES

These drawings, concepts, and details contained herein are the original proprietary designs of SPAS BY RENEE, developed over many years of experience in the industry and as such are protected by the copyright laws of the United States Government. Reproduction of any of the above without written permission to do so by SPAS BY RENEE, is illegal.

SPAS BY RENEE
6280 PECOS ROAD STE. 600
LAS VEGAS, NV 89120
Office: (702) 458-8862 Fax: (702) 458-2315



If printing as a PDF:

Page Scaling:

DWG NAME

FLAMINGO HILTON

SCALE
 1/2" = 1'

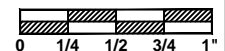

DATE
 12/16/2010

DWG TYPE
 RETURN Plumbing
 SHEET
 PAGE 4 OF 17

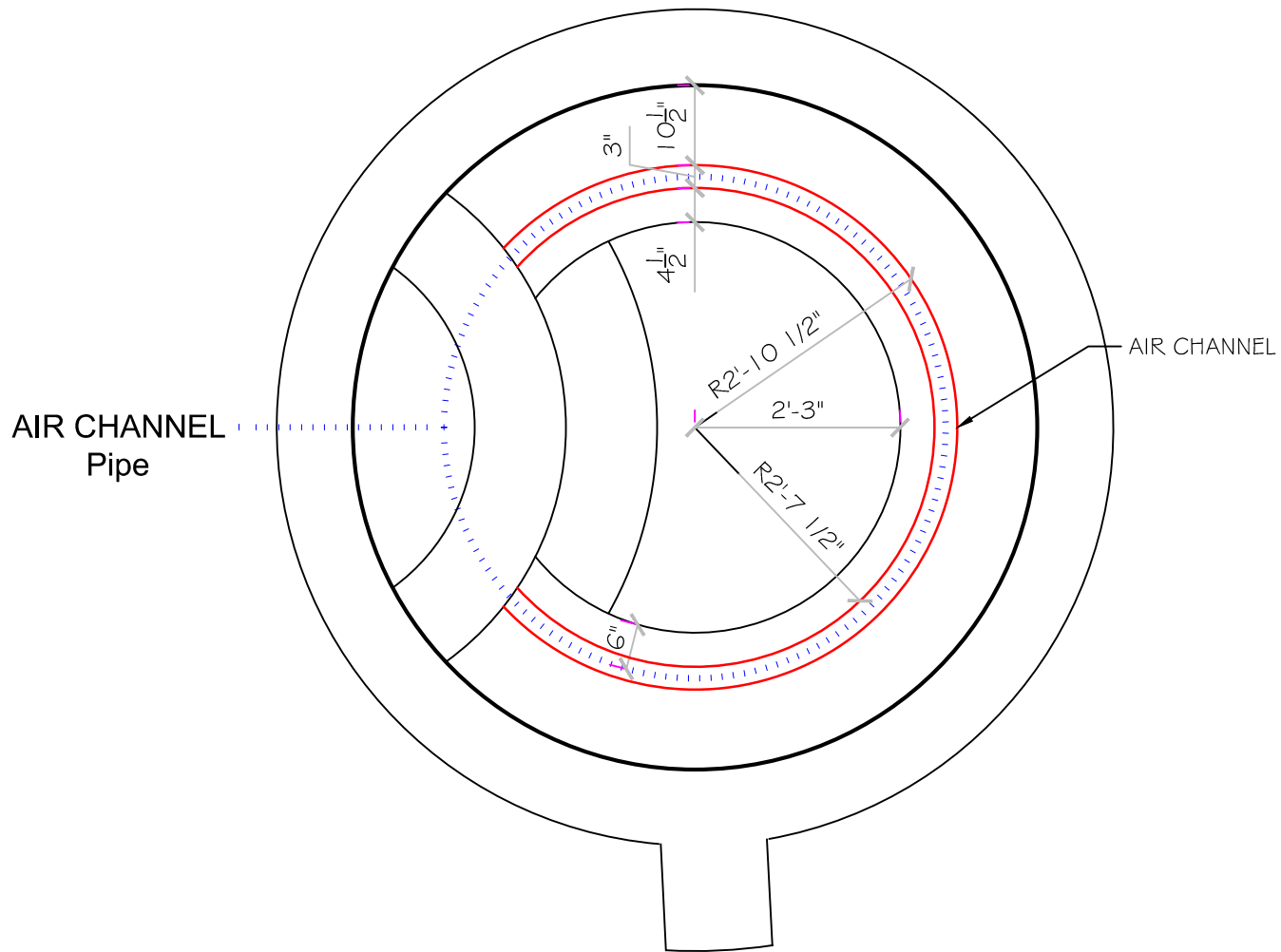

APPROVED

ALL DIMENSIONS SUBJECT TO 1/4" TOLERANCES

These drawings, concepts, and details contained herein are the original proprietary designs of SPAS BY RENEE, developed over many years of experience in the industry and as such are protected by the copyright laws of the United States Government. Reproduction of any of the above without written permission to do so by SPAS BY RENEE, is illegal.

SPAS BY RENEE
6280 PECOS ROAD STE. 600
LAS VEGAS, NV 89120
Office: (702) 458-8862 Fax: (702) 458-2315



If printing as a PDF:

Page Scaling:

SCALE
 1/2" = 1'

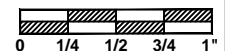

DWG NAME
 FLAMINGO HILTON

DATE
 12/16/2010

DWG TYPE
 Air Channel
 SHEET
 PAGE 5 OF 17

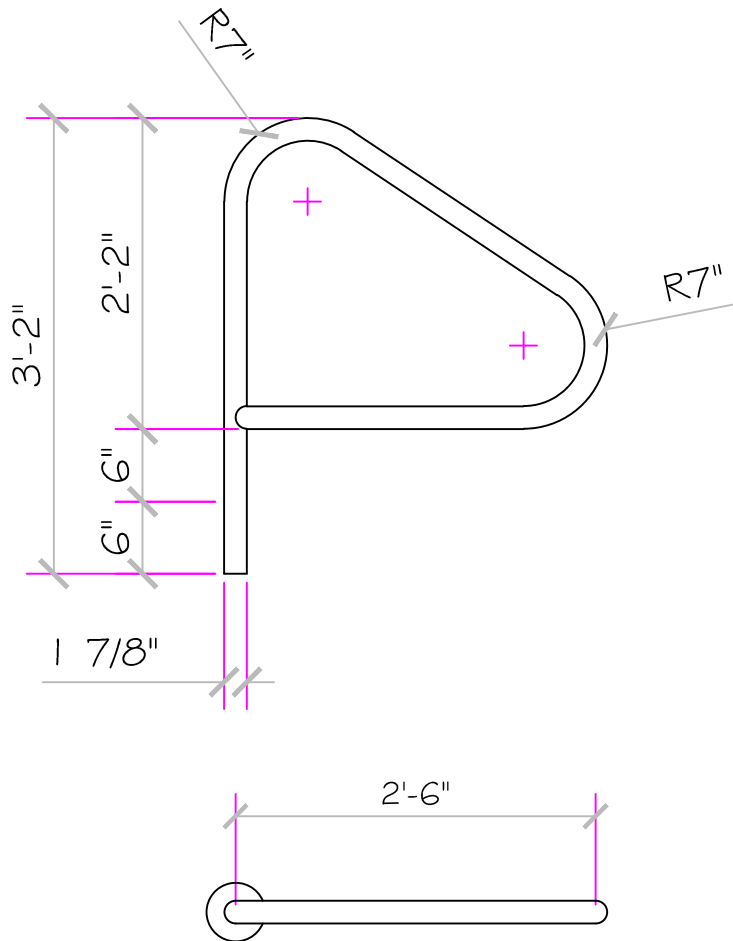
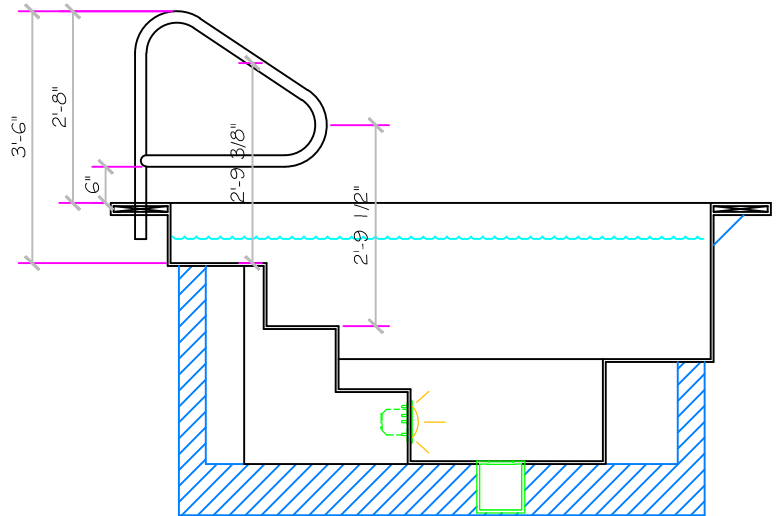
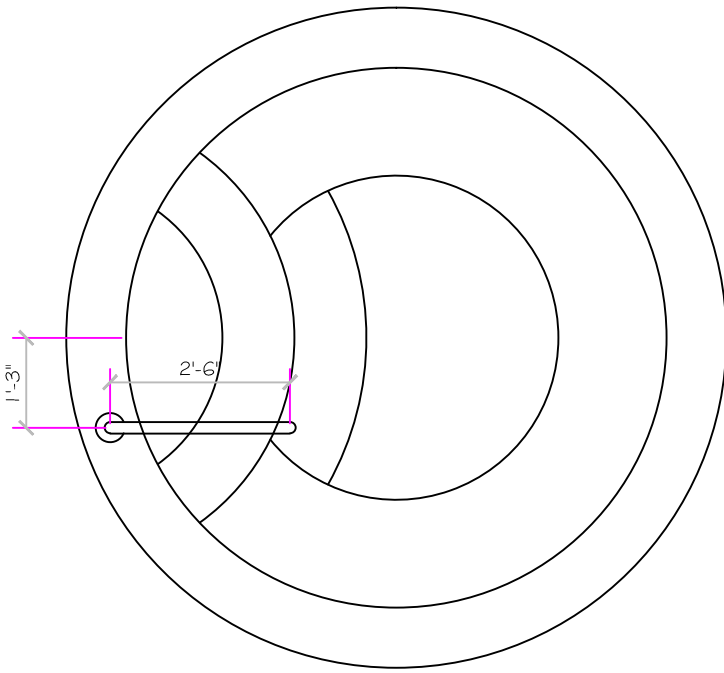

APPROVED

ALL DIMENSIONS SUBJECT TO 1/4" TOLERANCES

SPAS BY RENEE
 6280 PECOS ROAD STE. 600
 LAS VEGAS, NV 89120
 Office: (702) 458-8862 Fax: (702) 458-2315



If printing as a PDF:

Page Scaling:

DWG NAME: FLAMINGO HILTON

SCALE: 3/4" = 1'

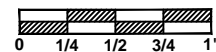

DATE: 12/16/2010

DWG TYPE: Model

SHEET: PAGE 6 OF 17

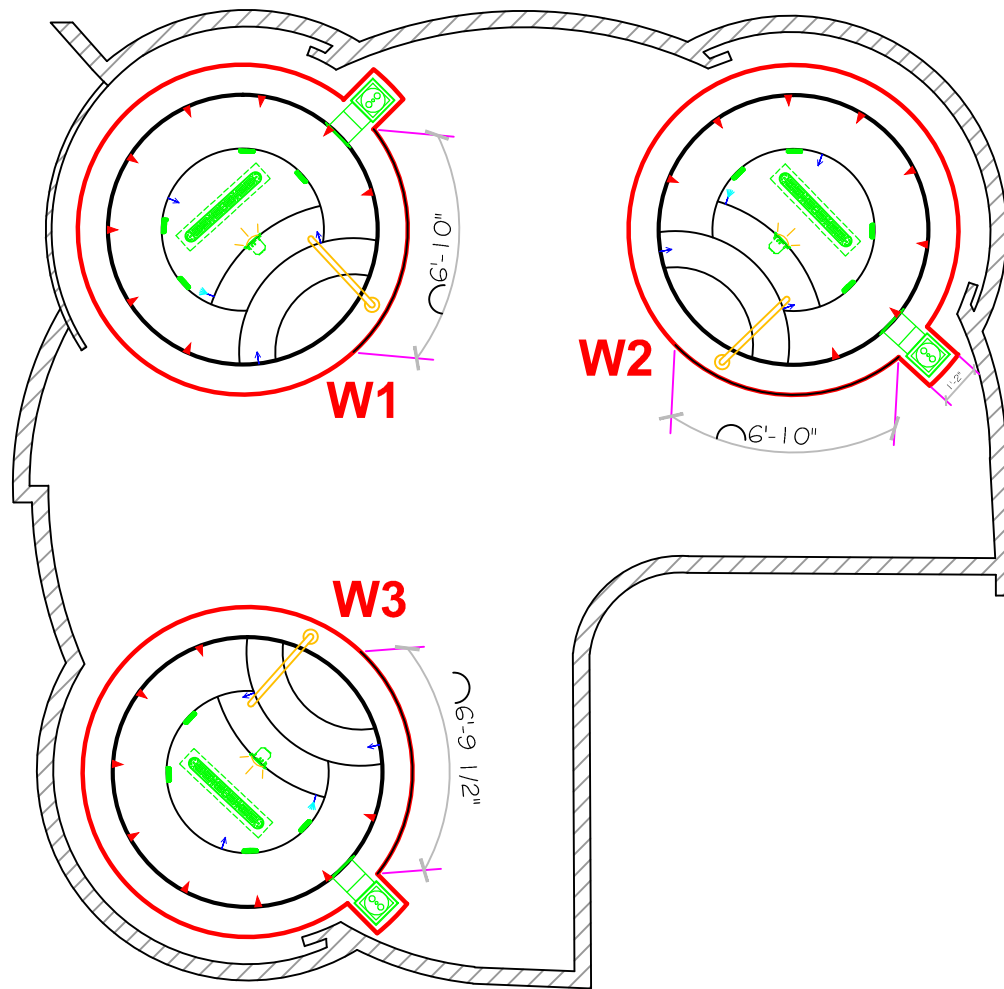

APPROVED

ALL DIMENSIONS SUBJECT TO 1/4" TOLERANCES

These drawings, concepts, and details contained herein are the original proprietary designs of SPAS BY RENEE, developed over many years of experience in the industry and as such are protected by the copyright laws of the United States Government. Reproduction of any of the above without written permission to do so by SPAS BY RENEE, is illegal.

SPAS BY RENEE
6280 PECOS ROAD STE. 600
LAS VEGAS, NV 89120
Office: (702) 458-8862 Fax: (702) 458-2315



If printing as a PDF:

Page Scaling:

SCALE
 3/16" = 1'

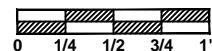

DWG TYPE
 Women's SPA Layout

DWG NAME
 FLAMINGO HILTON

DATE
 1/14/2011

SHEET
 PAGE 7 OF 17

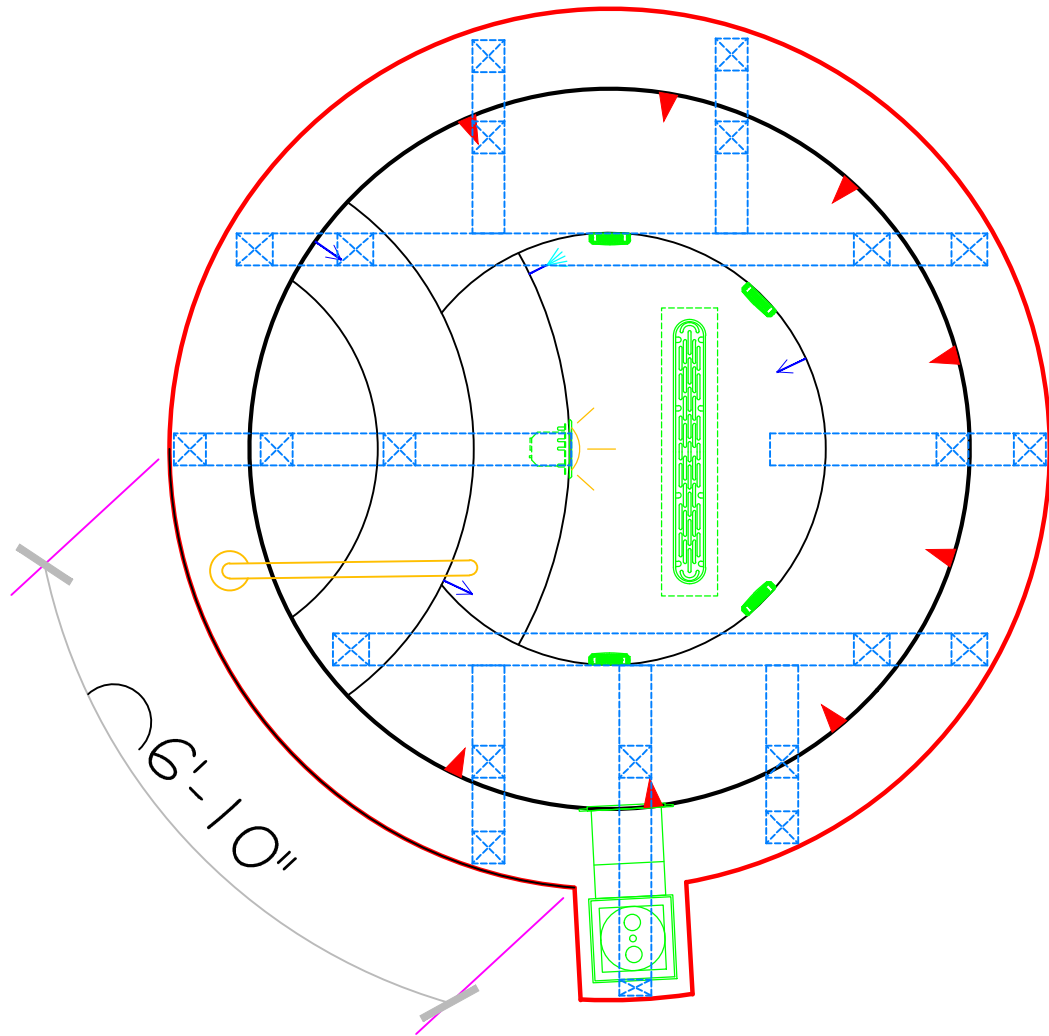

APPROVED

ALL DIMENSIONS SUBJECT TO 1/4" TOLERANCES

SPAS BY RENEE
 6280 PECOS ROAD STE. 600
 LAS VEGAS, NV 89120
 Office: (702) 458-8862 Fax: (702) 458-2315



If printing as a PDF:

Page Scaling:

SCALE
 1/2" = 1'

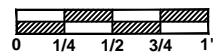

DWG TYPE
 SD-W1

DWG NAME
 FLAMINGO HILTON

DATE
 1/14/2011

SHEET
 PAGE 8 OF 17

These drawings, concepts, and details contained herein are the original proprietary designs of SPAS BY RENEE, developed over many years of experience in the industry and as such are protected by the copyright laws of the United States Government. Reproduction of any of the above without written permission to do so by SPAS BY RENEE, is illegal.

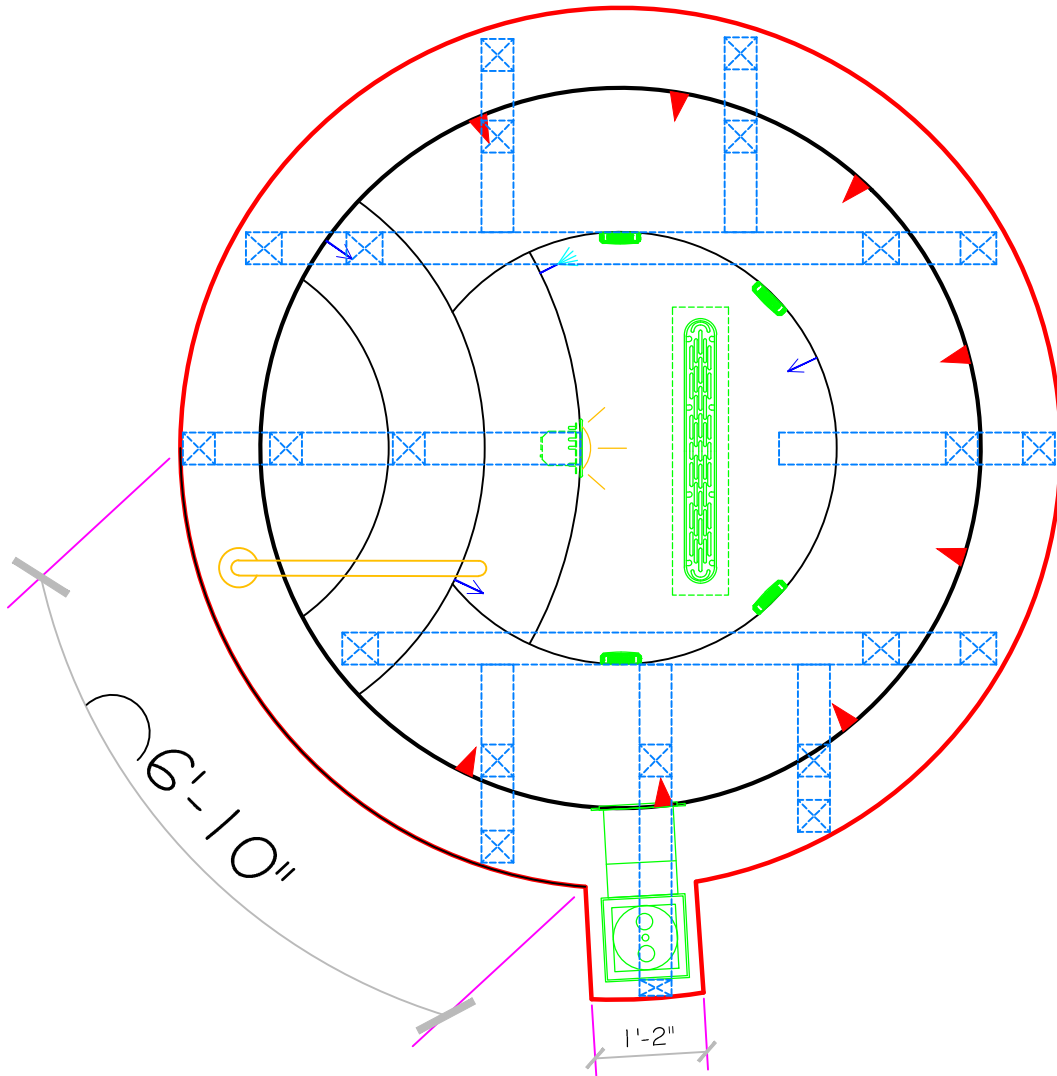

APPROVED

ALL DIMENSIONS SUBJECT TO 1/4" TOLERANCES

SPAS BY RENEE
 6280 PECOS ROAD STE. 600
 LAS VEGAS, NV 89120
 Office: (702) 458-8862 Fax: (702) 458-2315



If printing as a PDF:

Page Scaling:

SCALE
 1/2" = 1'

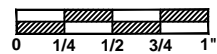

DWG TYPE
 SD-W2

DWG NAME
 FLAMINGO HILTON

DATE
 1/14/2011

SHEET
 PAGE 9 OF 17

These drawings, concepts, and details contained herein are the original proprietary designs of SPAS BY RENEE, developed over many years of experience in the industry and as such are protected by the copyright laws of the United States Government. Reproduction of any of the above without written permission to do so by SPAS BY RENEE, is illegal.

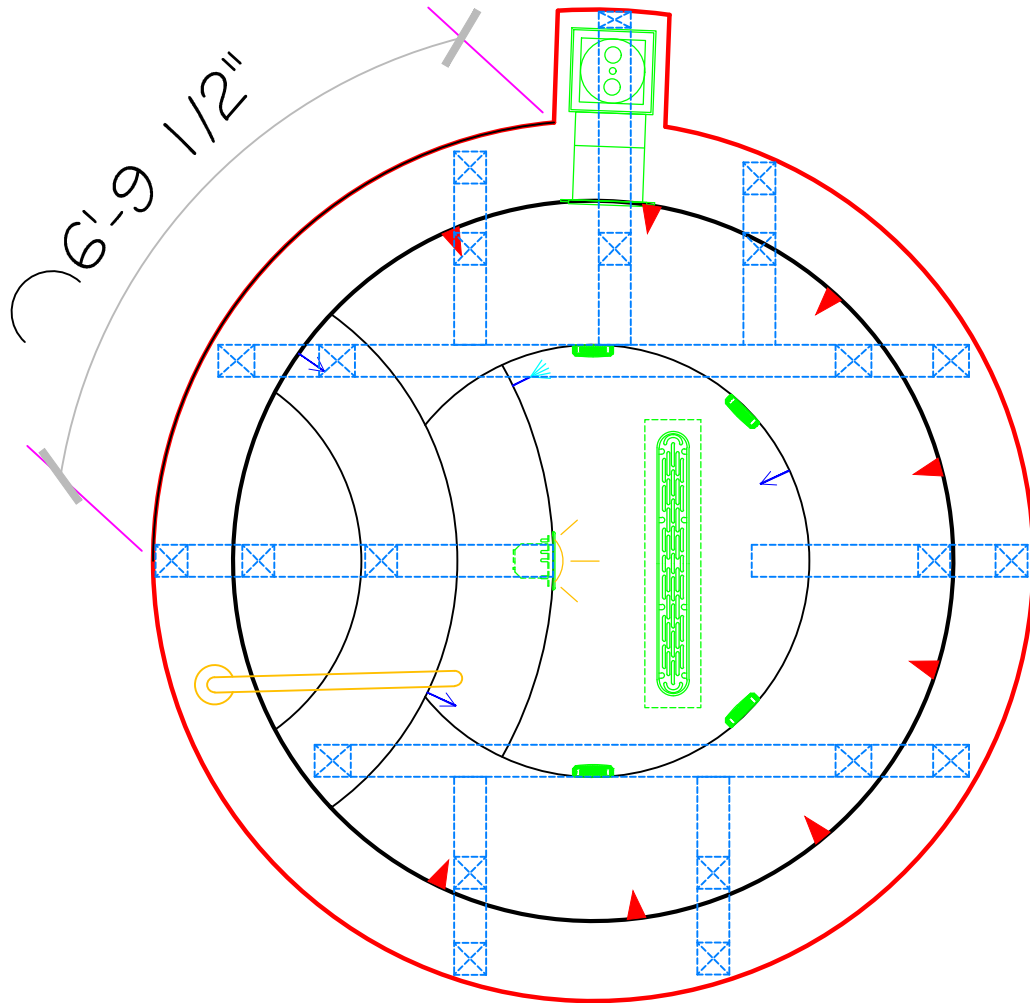

APPROVED

ALL DIMENSIONS SUBJECT TO 1/4" TOLERANCES

SPAS BY RENEE
 6280 PECOS ROAD STE. 600
 LAS VEGAS, NV 89120
 Office: (702) 458-8862 Fax: (702) 458-2315



If printing as a PDF:

Page Scaling:

SCALE
 1/2" = 1'

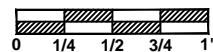

DWG TYPE
 SD-W3

DWG NAME
 FLAMINGO HILTON

DATE
 1/14/2011

SHEET
 PAGE 10 OF 17

These drawings, concepts, and details contained herein are the original proprietary designs of SPAS BY RENEE, developed over many years of experience in the industry and as such are protected by the copyright laws of the United States Government. Reproduction of any of the above without written permission to do so by SPAS BY RENEE, is illegal.

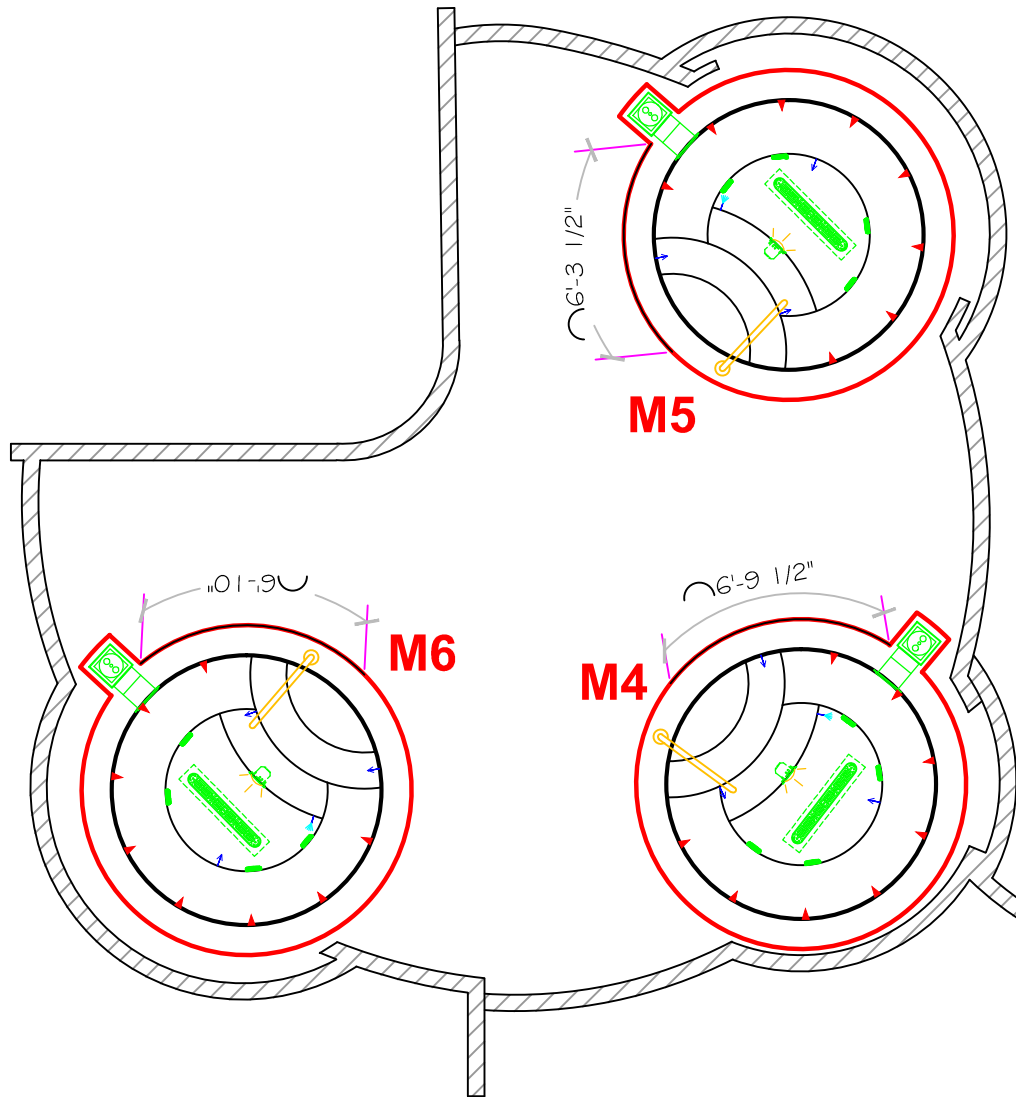

APPROVED

ALL DIMENSIONS SUBJECT TO 1/4" TOLERANCES

These drawings, concepts, and details contained herein are the original proprietary designs of SPAS BY RENEE, developed over many years of experience in the industry and as such are protected by the copyright laws of the United States Government. Reproduction of any of the above without written permission to do so by SPAS BY RENEE, is illegal.

SPAS BY RENEE
6280 PECOS ROAD STE. 600
LAS VEGAS, NV 89120
Office: (702) 458-8862 Fax: (702) 458-2315



If printing as a PDF:

Page Scaling:

DWG NAME

FLAMINGO HILTON

SCALE
 3/16" = 1'

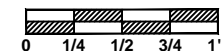

DATE

1/14/2011

DWG TYPE
 Men's SPA Layout

SHEET
 PAGE 11 OF 17

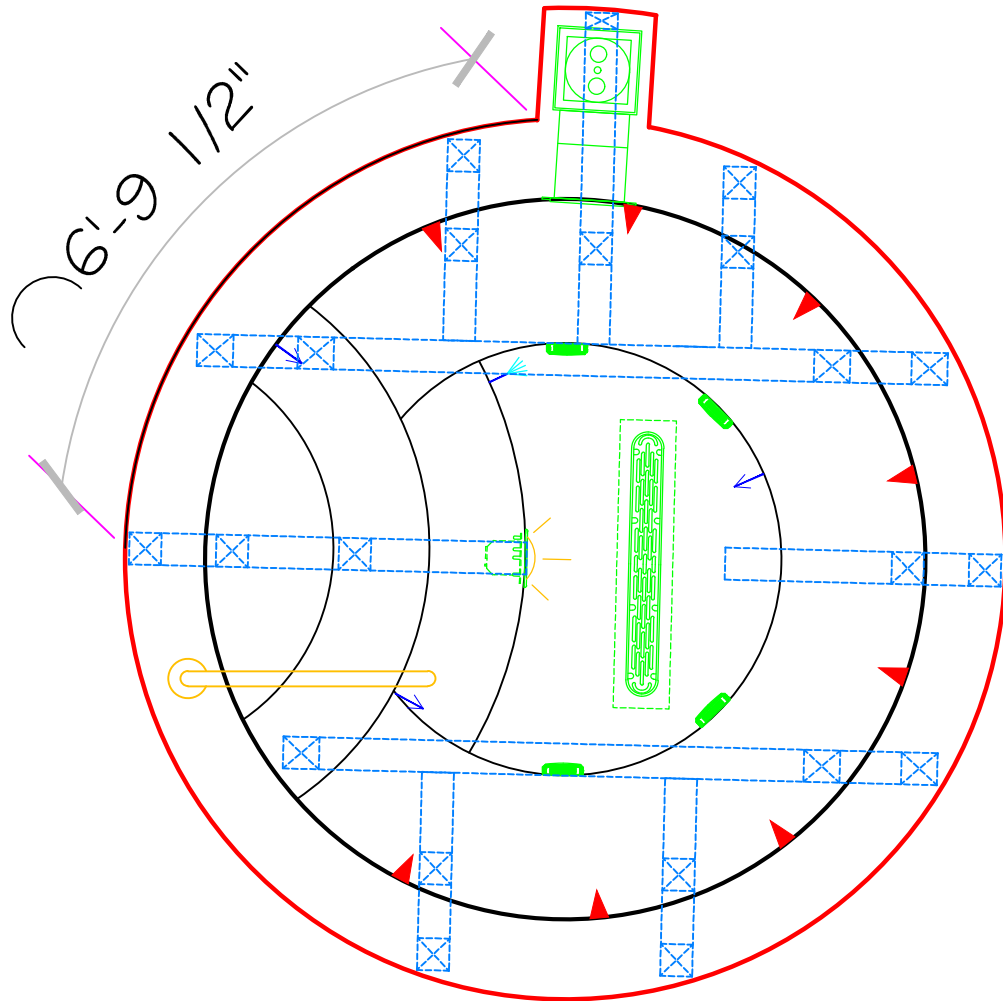

APPROVED

ALL DIMENSIONS SUBJECT TO 1/4" TOLERANCES

SPAS BY RENEE
 6280 PECOS ROAD STE. 600
 LAS VEGAS, NV 89120
 Office: (702) 458-8862 Fax: (702) 458-2315



If printing as a PDF:

Page Scaling:

SCALE
 1/2" = 1'

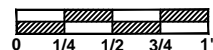

DWG TYPE
 SD-M4

DWG NAME
 FLAMINGO HILTON

DATE
 1/14/2011

SHEET
 PAGE 12 OF 17

These drawings, concepts, and details contained herein are the original proprietary designs of SPAS BY RENEE, developed over many years of experience in the industry and as such are protected by the copyright laws of the United States Government. Reproduction of any of the above without written permission to do so by SPAS BY RENEE, is illegal.

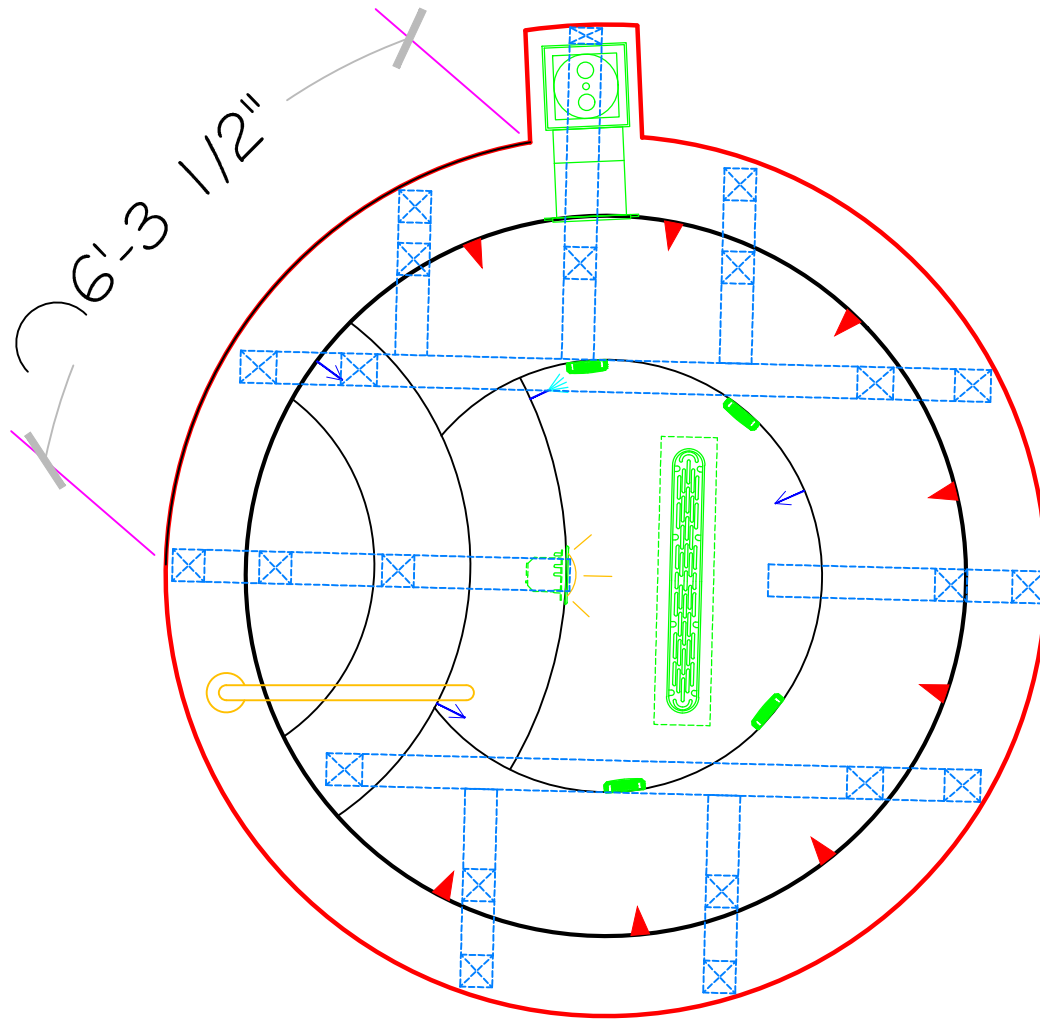

APPROVED

ALL DIMENSIONS SUBJECT TO 1/4" TOLERANCES

SPAS BY RENEE
 6280 PECOS ROAD STE. 600
 LAS VEGAS, NV 89120
 Office: (702) 458-8862 Fax: (702) 458-2315



If printing as a PDF:

Page Scaling:

SCALE
 1/2" = 1'

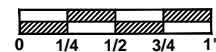

DWG TYPE
 SD-M5

DWG NAME
 FLAMINGO HILTON

DATE
 1/14/2011

SHEET
 PAGE 13 OF 17

These drawings, concepts, and details contained herein are the original proprietary designs of SPAS BY RENEE, developed over many years of experience in the industry and as such are protected by the copyright laws of the United States Government. Reproduction of any of the above without written permission to do so by SPAS BY RENEE, is illegal.

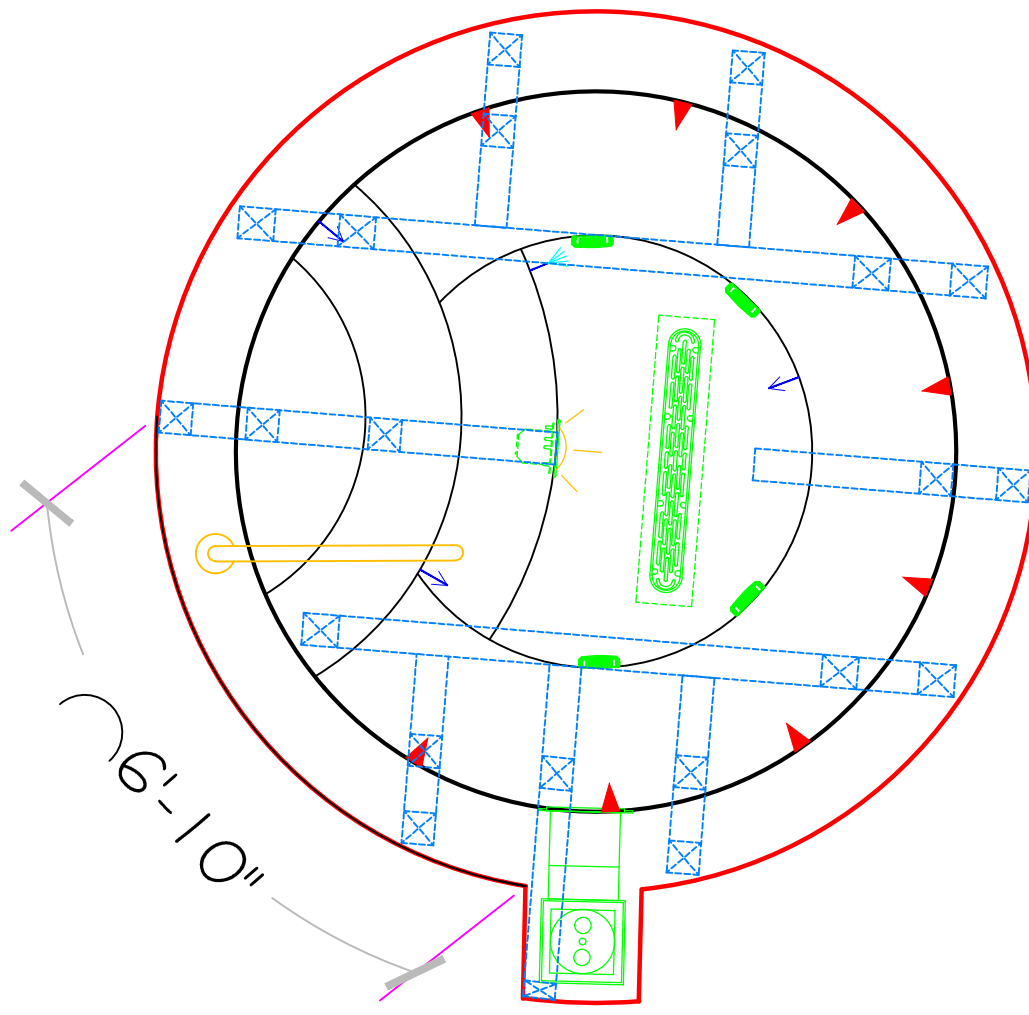

APPROVED

ALL DIMENSIONS SUBJECT TO 1/4" TOLERANCES

SPAS BY RENEE
 6280 PECOS ROAD STE. 600
 LAS VEGAS, NV 89120
 Office: (702) 458-8862 Fax: (702) 458-2315



If printing as a PDF:

Page Scaling:

SCALE
 1/2" = 1'

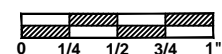

DWG TYPE
 SD-M6

DWG NAME
 FLAMINGO HILTON

DATE
 1/14/2011

SHEET
 PAGE 14 OF 17

These drawings, concepts, and details contained herein are the original proprietary designs of SPAS BY RENEE, developed over many years of experience in the industry and as such are protected by the copyright laws of the United States Government. Reproduction of any of the above without written permission to do so by SPAS BY RENEE, is illegal.

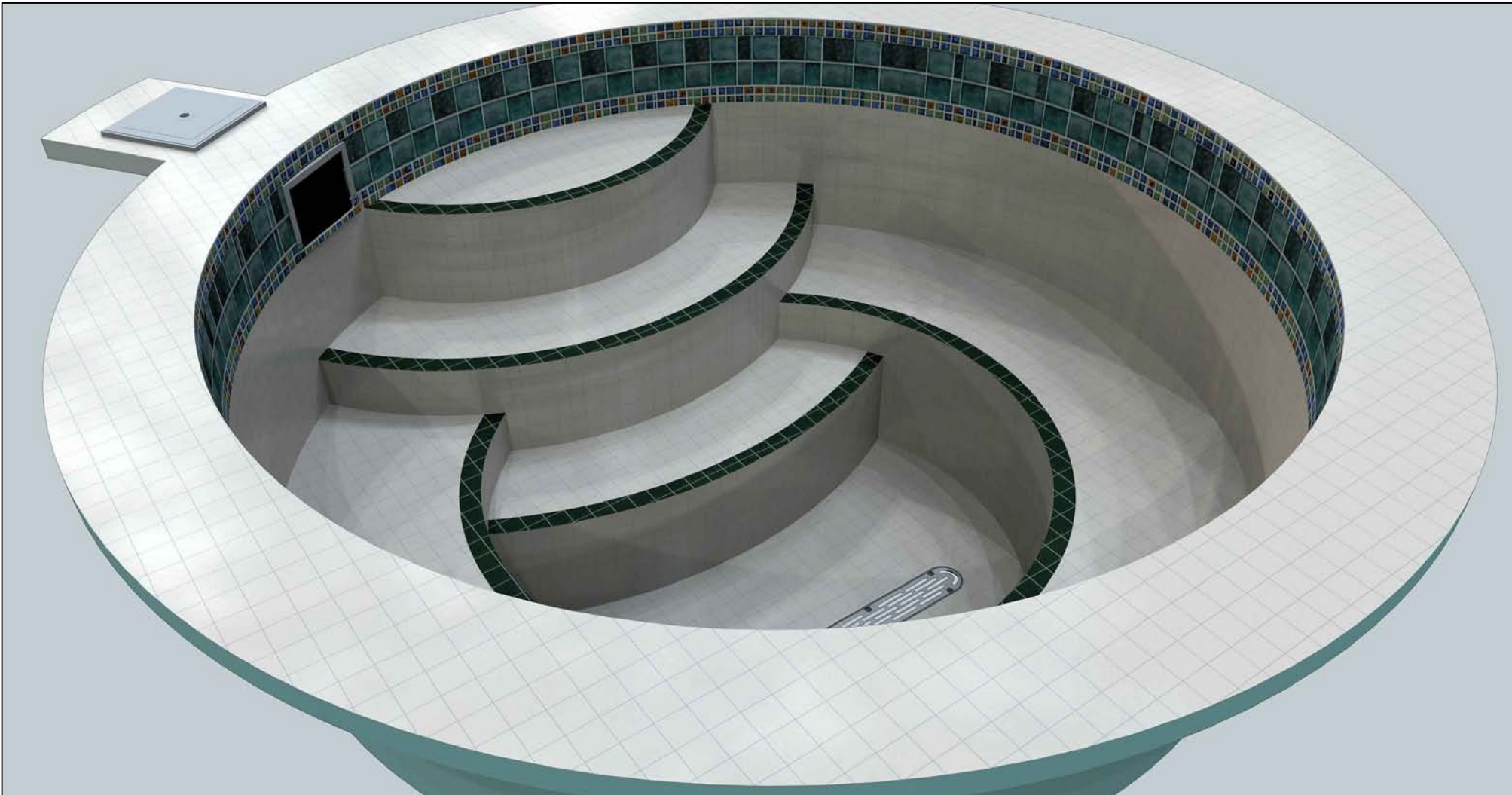

APPROVED

ALL DIMENSIONS SUBJECT TO 1/4" TOLERANCES

These drawings, concepts, and details contained herein are the original proprietary designs of SPAS BY RENEE, developed over many years of experience in the industry and as such are protected by the copyright laws of the United States Government. Reproduction of any of the above without written permission to do so by SPAS BY RENEE, is illegal.

SPAS BY RENEE
6280 PECOS ROAD STE. 600
LAS VEGAS, NV 89120
Office: (702) 458-8862 Fax: (702) 458-2315



If printing as a PDF:

Page Scaling:

SCALE
N/A

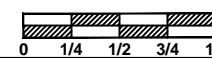

DWG TYPE

Render

DWG NAME

FLAMINGO HILTON

DATE

12/16/2010

SHEET

PAGE 15 OF 17



APPROVED

ALL DIMENSIONS SUBJECT TO 1/4" TOLERANCES

These drawings, concepts, and details contained herein are the original proprietary designs of SPAS BY RENEE, developed over many years of experience in the industry and as such are protected by the copyright laws of the United States Government. Reproduction of any of the above without written permission to do so by SPAS BY RENEE, is illegal.

SPAS BY RENEE
6280 PECOS ROAD STE. 600
LAS VEGAS, NV 89120
Office: (702) 458-8862 Fax: (702) 458-2315



If printing as a PDF:

Page Scaling:

DWG NAME

SCALE

N/A

FLAMINGO HILTON

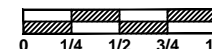

DATE

12/16/2010

DWG TYPE

Render (2)

SHEET

PAGE 16 OF 17

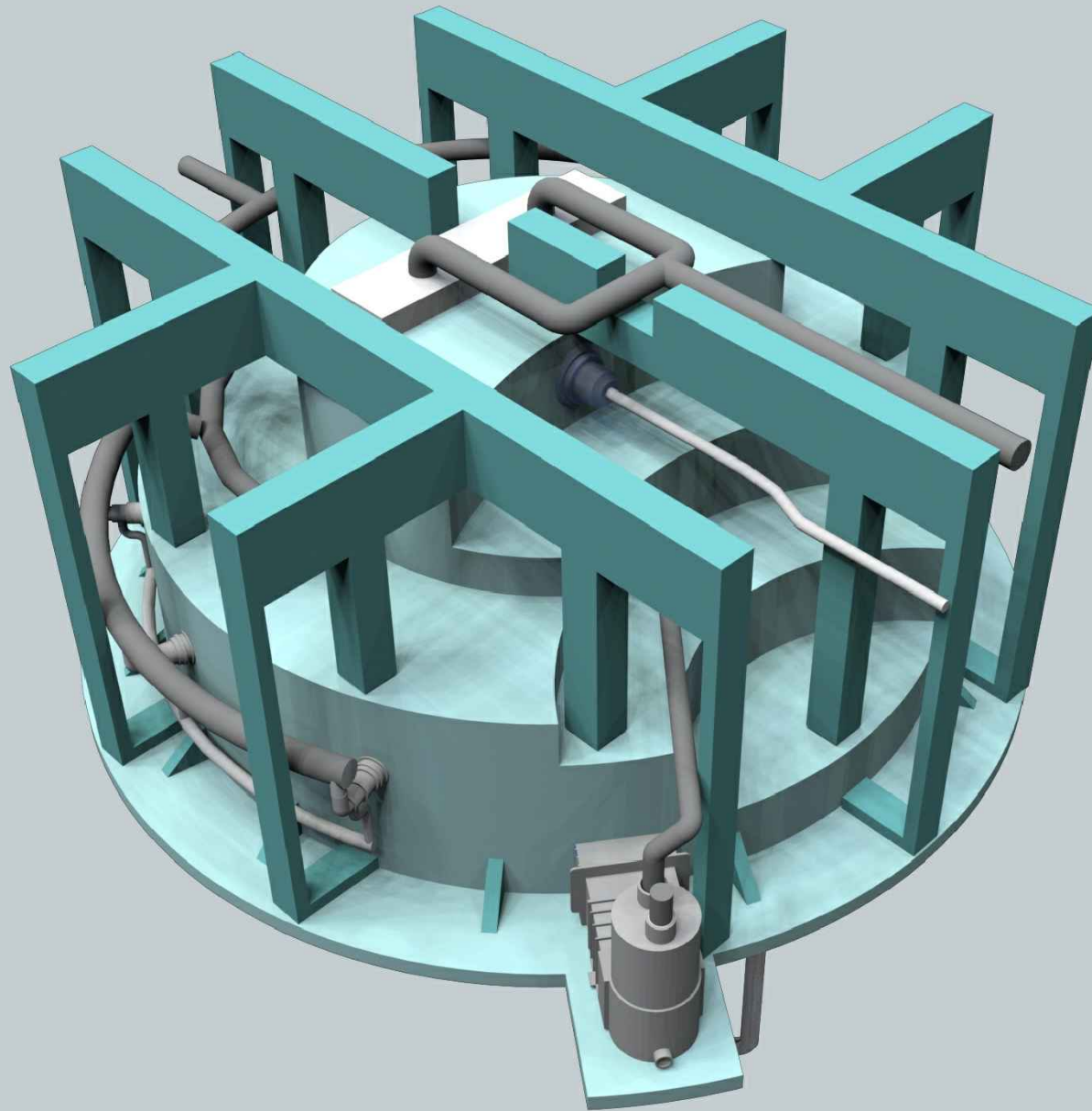

APPROVED

ALL DIMENSIONS SUBJECT TO 1/4" TOLERANCES

These drawings, concepts, and details contained herein are the original proprietary designs of SPAS BY RENEE, developed over many years of experience in the industry and as such are protected by the copyright laws of the United States Government. Reproduction of any of the above without written permission to do so by SPAS BY RENEE, is illegal.

SPAS BY RENEE
6280 PECOS ROAD STE. 600
LAS VEGAS, NV 89120
Office: (702) 458-8862 Fax: (702) 458-2315



If printing as a PDF:

Page Scaling:

SCALE
N/A

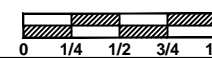

DWG TYPE

Render (3)

DWG NAME

FLAMINGO HILTON

DATE

12/16/2010

SHEET

PAGE 17 OF 17