



NESPA
TILED SPAS

Production Booklet

for

G-8 SPA

2800 Richter Ave. Suite C, Oroville, CA 95965 • **voice:** (530)534-9910
fax: (530)534-9915 • **email:** sales@tiledspas.com • **website:** www.tiledspas.com



RECOMMENDED MAINTENANCE

Please Note:

These are only recommended guidelines to care for a Nespa all tiled spa. Local codes may require additional procedures, therefore consult with a pool professional that is LA county Health Department certified for more information on local codes and requirements.

SPA SURFACE

Your spa tile is acid resistant and frost-proof. The Tile does not absorb germs or algae. Tile does not stain and is very easy to clean. Color does not fade or lose its luster. All grouts are epoxy based and are extremely durable. To remove scum line use soft nylon brush and small amounts of biodegradable soaps. Do not use abrasive brushes or chemicals.

MAINTENANCE

A. CHEMICALS:

- 1) It is important to maintain a chlorine residual of 2 PPM in the spa. That residual can be provided by chlorine or bromine.
- 2) It is recommended to use Bromine or dichlor (granular) forms of chlorine. If bromine Tabs are used we suggest floating or inline dispenser.
- 3) Never use acid to lower Ph in the tile spa.
- 4) Never use trichlor chlorine (1" or 3") tablets in the Nespa spas.
- 5) Never place tablets in skimmer basket.

B. DRAINING THE SPA:

- 1) It is recommended to drain the spa at least once every 2 months depending on bath load and water clarity.
- 2) The spa should be drained through valve exiting re-circulation pump in the spa equipment room or sump pump.
- 3) Note: Use caution to drain spa in the winter months or rainy season when water table is at its highest. It is possible for the spa to float due to hydraulic pressure from surrounding water table. We advise that you consult with your local spa specialist prior to draining the spa.

C. SPA EQUIPMENT:

- 1) Clean filter cartridge at least once every month, or when needed; i.e., if water clarity does not improve after several days.
- 2) Keep area free and clear from leaves and debris build-up.
- 3) Keep area free and clear from flooding.

D. SPA LIGHT:

- 1) Spa light has to be on GFCI circuit. It is controlled at spa side with ON/OFF.

E. TILE SERVICING:

- 1) Contact manufacture when servicing tile or grout. @ (530) 534-9910

SPA MODEL:

Legacy 8' x 20' DS

Job #23

SPECIFICATIONS	
SHELL WEIGHT:	5200 LBS.
WATER WEIGHT:	22013 LBS.
TOTAL SHELL & WATER WEIGHT:	27213.3 LBS.
WATER VOLUME:	353 Cu.Ft.
WATER GALLONS:	2640 GAL.
SURFACE AREA:	154.6 SQ. FT.
ICC ES LISTED #:	PMG-1161

NESPA ENTERPRISES, Inc.



ICC ES Listed
PMG-1161

Compliance with the following codes:

- 2018, 2015, 2012 and 2009 International Swimming Pool and Spa Code
- 2015, 2012 and 2009 Uniform Swimming Pool, Spa and Hot Tub Code

**Uniform Swimming Pool, Spa and Hot Tub Code is a copyrighted publication of the International Association of Plumbing and Mechanical Officials*

Compliance with the following standards:

- IAPMO/ANSI Z124.7-2013, Prefabricated Plastic Spa Shells
- ANSI/APSP/ICC-3 2014, Permanently Installed Residential Spas and Swim Spas (formally ANSI/NSPI-3 2014)

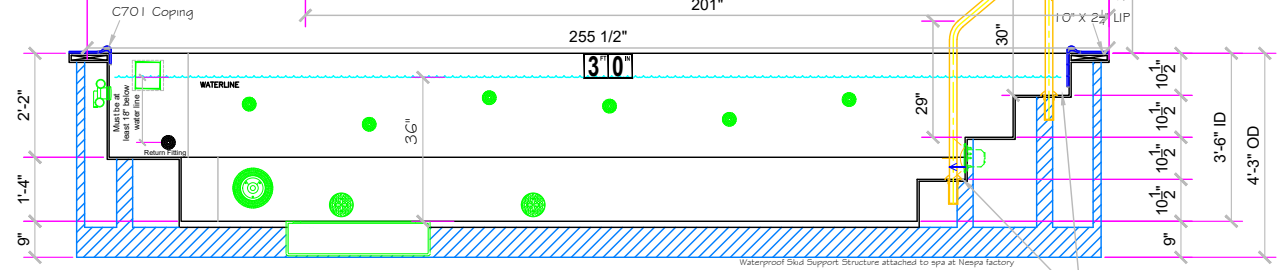
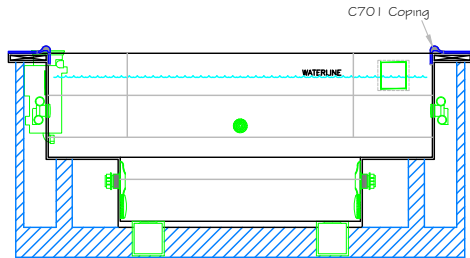
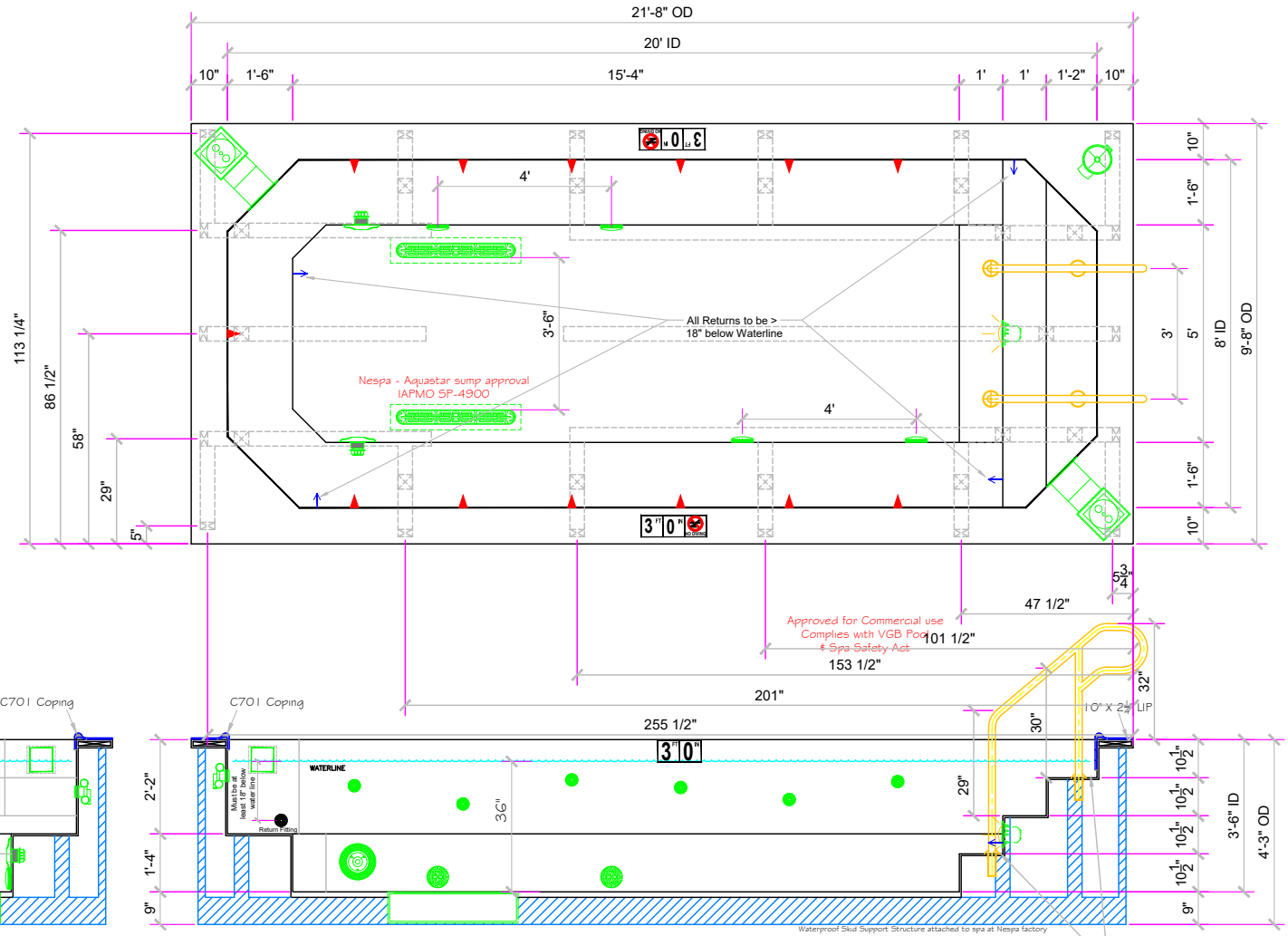

Location of cup anchors not to exceed 3\"/>

APPROVED

ALL DIMENSIONS SUBJECT TO 1/4\"/>

These drawings, concepts, and details contained herein are the original proprietary designs of **NESPA ENTERPRISES INC.**, developed over many years of experience in the industry and as such are protected by the copyright laws of the United States Government. Reproduction of any of the above without written permission to do so by **NESPA ENTERPRISES INC.**, is illegal

NESPA ENTERPRISES INC.
 2800 Richter Ave. Ste. C Oroville, CA 95966
 Office: (530) 534-9910 Fax: (530) 534-9915
 E-Mail: jim@tiledspas.com Web Site: www.tiledspas.com



If printing as a PDF:

Page Scaling:

DWG NAME **G-8**

SCALE
 1/4" = 1'

DATE
6/21/2018

DWG TYPE
SD

SHEET
PAGE 1 OF 9

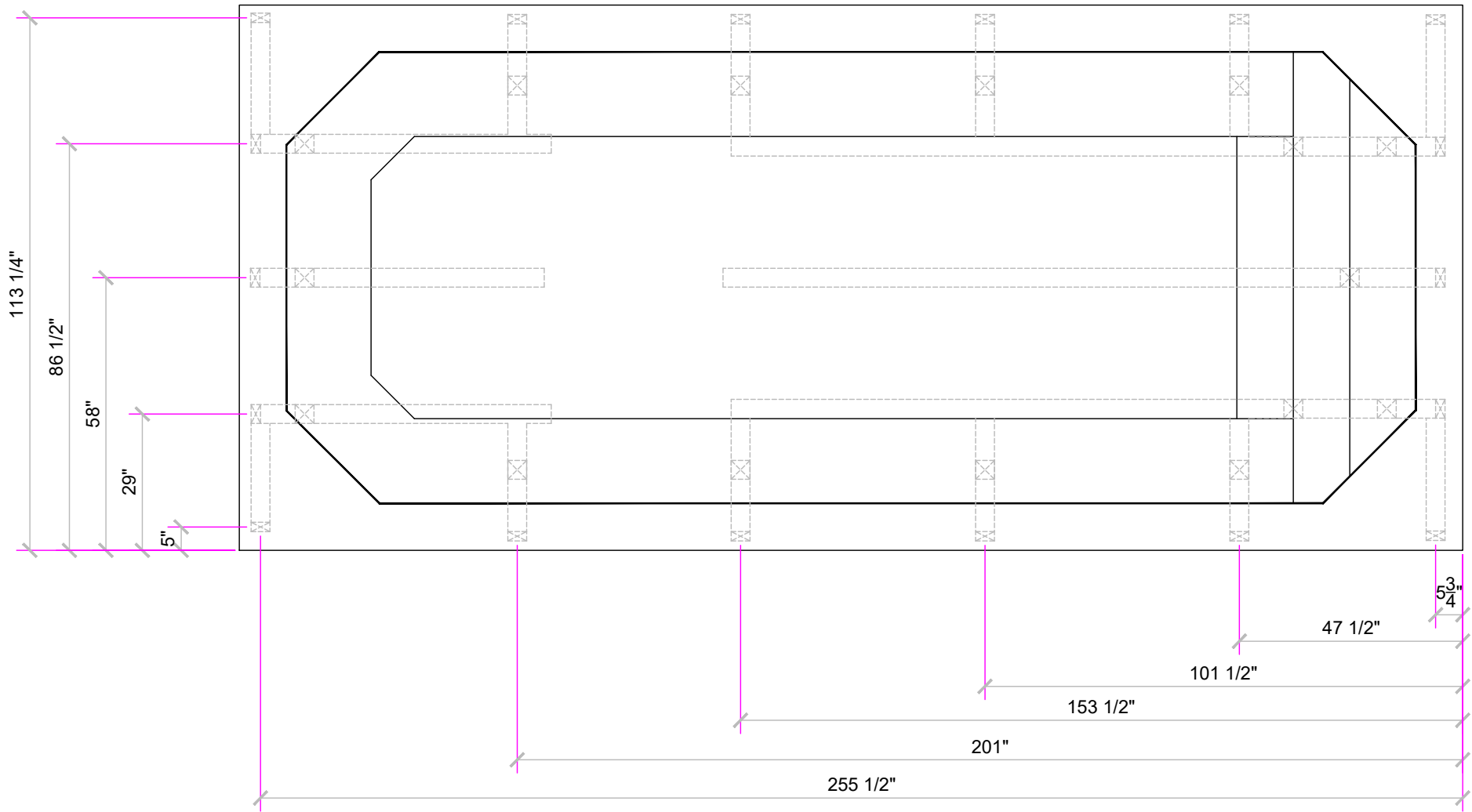

AS-BUILT

ALL DIMENSIONS SUBJECT TO 1/4" TOLERANCES

These drawings, concepts, and details contained herein are the original proprietary designs of **NESPA ENTERPRISES INC.**, developed over many years of experience in the industry and as such are protected by the copyright laws of the United States Government. Reproduction of any of the above without written permission to do so by **NESPA ENTERPRISES INC.**, is illegal.

NESPA ENTERPRISES INC.
 2800 Richter Ave. Ste. C Oroville, CA 95966
 Office: (530) 534-9910 Fax: (530) 534-9915
 E-Mail: jim@tiledspas.com Web Site: www.tiledspas.com



If printing as a PDF:
 Page Scaling:
 DWG NAME: G-8

SCALE: 3/8" = 1'
 DATE: 6/28/2018

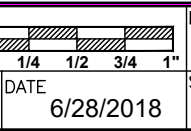

DWG TYPE: Skids
 SHEET: PAGE 1A OF 9

TILE

- #1 - FIELD TILE: DAL TILE D317 BISQUIT 2 X 2
- #2 - WATERLINE : NPT 3x3 Caribbean Blue - DSF95
3 X 3 - Gloss Finish
- #3 - TRIM TILE: DAL TILE D023 GALAXY 2 X 2
- #4 - TILED LIP (Edge Trim): DAL TILE C701 - D317 BISQUIT
- #5 - TILED LIP (Horizontal Field): DAL TILE D317 BISQUIT 2 X 2



DATE: _____

APPROVAL: _____

GROUT

- #1 - SPA Field Grout: CCure Epoxy White
- #2 - SPA Waterline Grout: Nespa Epoxy Blue
- #3 - SPA Horizontal Lip Grout: CCure Epoxy White

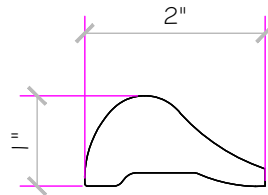

DETAIL

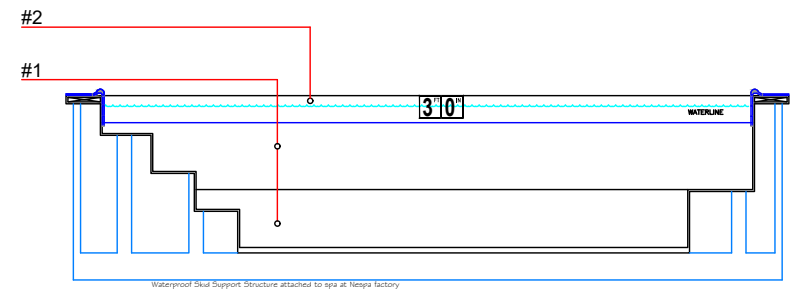
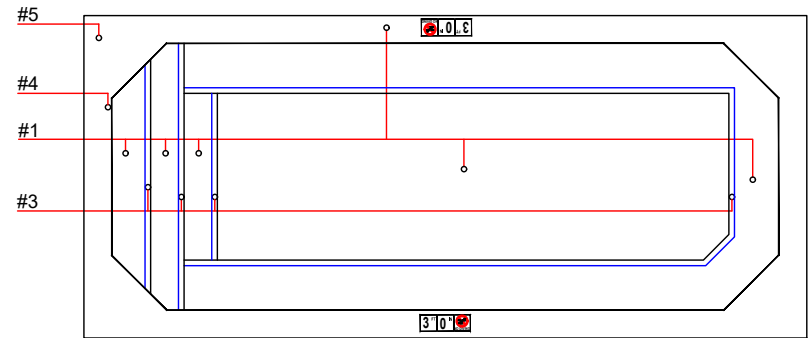
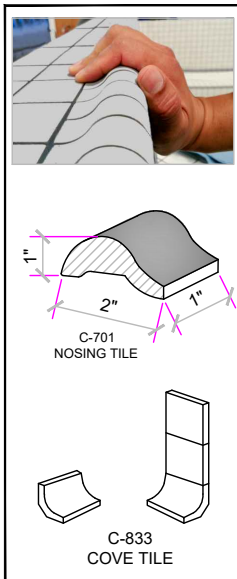
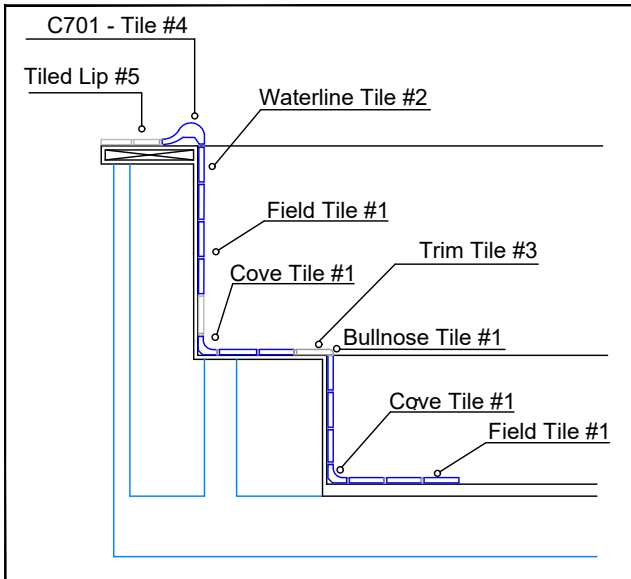

All corners / junctions of the Pool shall be covered.
All Horizontal Surfaces Shall be Slip Resistant Tile.

APPROVED

These drawings, concepts, and details contained herein are the original proprietary designs of **NESPA ENTERPRISES INC.**, developed over many years of experience in the industry and as such are protected by the copyright laws of the United States Government. Reproduction of any of the above without written permission to do so by **NESPA ENTERPRISES INC.**, is illegal

NESPA ENTERPRISES INC.
2800 Richter Ave. Ste. C Oroville, CA 95966
Office: (530) 534-9910 Fax: (530) 534-9915
E-Mail: jim@tiledspas.com Web Site: www.tiledspas.com



If printing as a PDF:
Page Scaling: None
DWG NAME: G-8

SCALE
9/32" = 1'

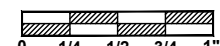

DATE
6/21/2018

DWG TYPE: Tile
SHEET: PAGE 2 OF 9

**NOTE: All Piping to be
Schedule 80**

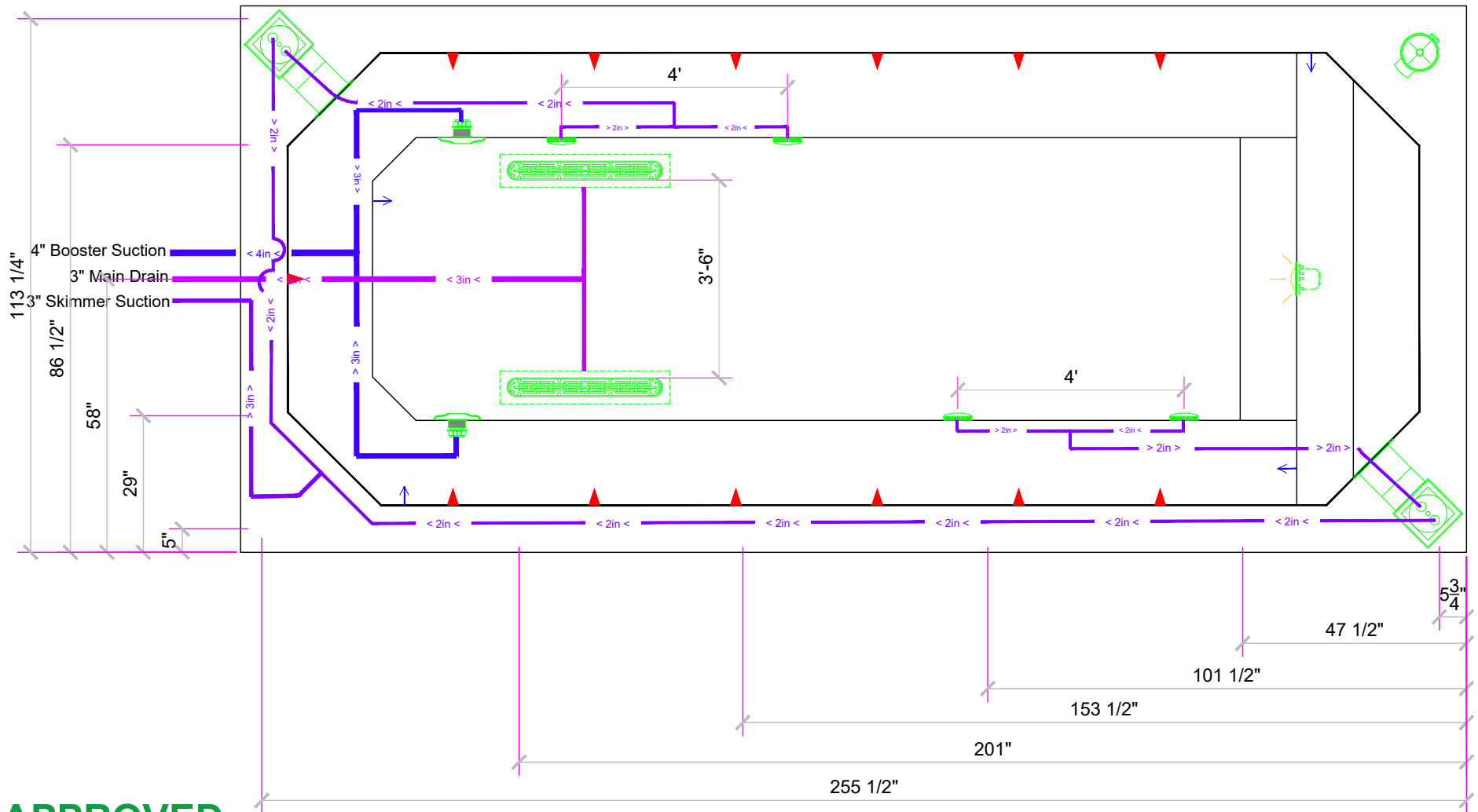

APPROVED

These drawings, concepts, and details contained herein are the original proprietary designs of **NESPA ENTERPRISES INC.**, developed over many years of experience in the industry and as such are protected by the copyright laws of the United States Government. Reproduction of any of the above without written permission to do so by **NESPA ENTERPRISES INC.**, is illegal.

NESPA ENTERPRISES INC.
2800 Richter Ave. Ste. C Oroville, CA 95966
Office: (530) 534-9910 Fax: (530) 534-9915
E-Mail: jim@tiledspas.com Web Site: www.tiledspas.com



If printing as a PDF:

Page Scaling:

DWG NAME

G-8

SCALE

3/8" = 1'

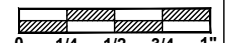

DATE

6/21/2018

DWG TYPE

Suction Plumbing

SHEET

PAGE 3 OF 9

**NOTE: All Piping to be
Schedule 80**

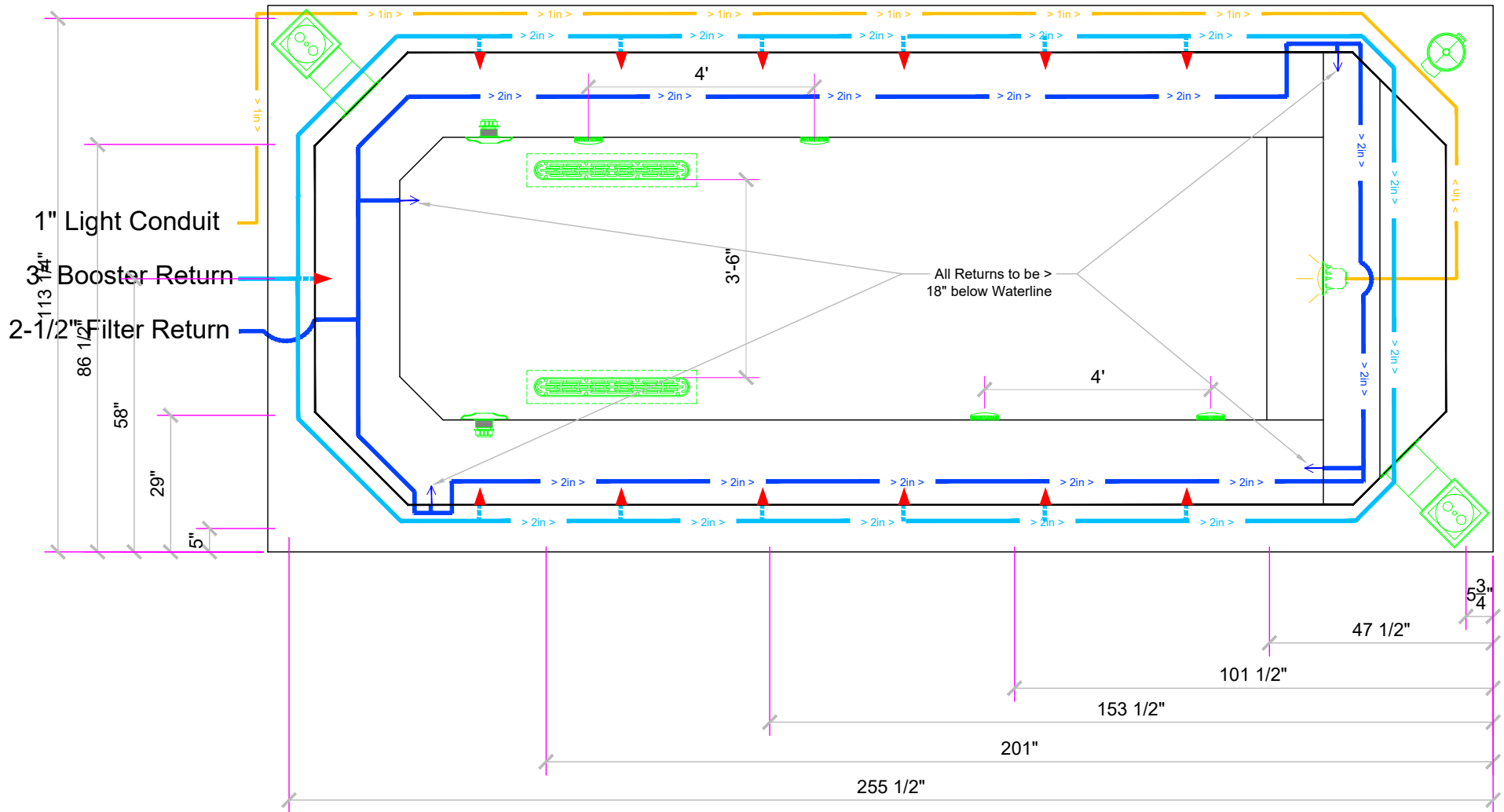

APPROVED

These drawings, concepts, and details contained herein are the original proprietary designs of **NESPA ENTERPRISES INC.**, developed over many years of experience in the industry and as such are protected by the copyright laws of the United States Government. Reproduction of any of the above without written permission to do so by **NESPA ENTERPRISES INC.**, is illegal.

NESPA ENTERPRISES INC.
2800 Richter Ave. Ste. C Oroville, CA 95966
Office: (530) 534-9910 Fax: (530) 534-9915
E-Mail: jim@tiledspas.com Web Site: www.tiledspas.com



If printing as a PDF:

Page Scaling:





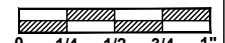







DWG NAME
G-8

SCALE
3/8" = 1'



DATE
5/23/2018

DWG TYPE
Return Plumbing
SHEET
PAGE 4 OF 9

EQUIPMENT LIST						
ITEM	CODE	EQUIPMENT	DESCRIPTION	MANUFACTURER	CATALOG NO.	QTY.
1	SS		SURFACE SKIMMER - AUTOMATIC W/ EQUALIZER, NSF APPROVED	HAYWARD	SP-1084FVE	2
2	BS		Paramount SDX 10" HIGH FLOW SAFETY DRAIN Area of Opening = 43.201 in/sq Velocity @ 200 GPM = 1.485 fps V.G.B Approved Safety Drain Complies w/ ANSI / ASME A112.19.8 & NSF / ANSI 16-2011	PARAMOUNT	SDX 004-182-2212-01	2
3	MD		MAIN DRAIN: AQUASTAR 32CDFLFR, 32" CHANNEL DRAIN, Approved Max Flow Rate: Floor = 316 GPM @ 3.9 fps Complies w/ ANSI / ASME A112.19.8 & NSF / ANSI 16-2011 - V.G.B APPROVED 6" Round Hockey puck - Surpluss Suction Outlet	AQUASTAR	32CDFLFR101	2
4	EQ		Floor 177 GPM - Wall 122 GPM Complies w/ ANSI / ASME A112.19.8 & ANSI / APSF-16 for anti-hair and body entrapment Suction outlets comply with ANSI / APSF-7	AQUASTAR	6HPHxxxx	4
5	J#		HYDRO JETS 1-1/2" WATER - 1-1/2" AIR Complies w/ ANSI / ASME A112.19.8 & ANSI / APSF-16 - UL APPROVED	HYDROAIR	10-5100	13
6	WI		INLET FITTINGS 1-1/2" WALL TYPE W/ EYEBALL COMPLIES W/ ANSI CODE ASME A112.19.8-07 UL APPROVED	HYDROAIR	10-3500	4
7	UL		LIGHT NICHE (FOR UNDERWATER LIGHT) W/ 1" HUB	PENTAIR	78242300	1
8	UL		PENTAIR INTELLIBRITE 5g, 120 V, 100 WATT U.L. APPROVED	PENTAIR	64014	1
9	HR		HAND RAIL, STAINLESS STEEL, 3' - 6" LENGTH,	SR SMITH	P-Rail	2
10	CA		CUP ANCHOR: 6" BIG BOY SOCKET - USES PW-4C WEDGE	PERMA-CAST	PS-6019-BC	4
11	PB		POOL BOND	PERMA-CAST	PB-2008	1
12	MP		AUTOFILL DEVICE	MP Industries	MP 1953 J	1

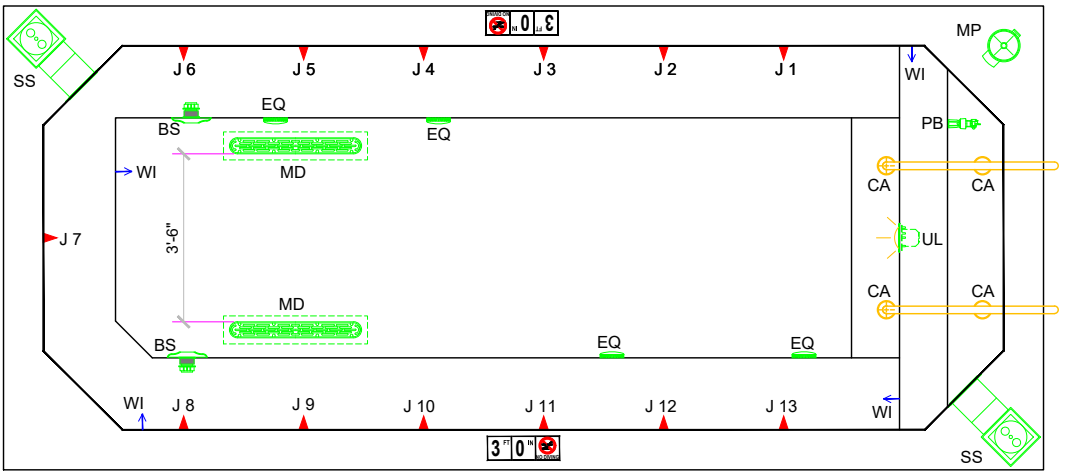

APPROVED

These drawings, concepts, and details contained herein are the original proprietary designs of **NESPA ENTERPRISES INC.**, developed over many years of experience in the industry and as such are protected by the copyright laws of the United States Government. Reproduction of any of the above without written permission to do so by **NESPA ENTERPRISES INC.**, is illegal.

NESPA ENTERPRISES INC.
 2800 Richter Ave. Ste. C Oroville, CA 95966
 Office: (530) 534-9910 Fax: (530) 534-9915
 E-Mail: jim@tiledspas.com Web Site: www.tiledspas.com



If printing as a PDF:
 Page Scaling: None
 DWG NAME: G-8

SCALE
 1/4" = 1'

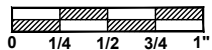

DATE
 6/21/2018

DWG TYPE: EQ
 SHEET: PAGE 5 OF 9

EQUIPMENT LIST						
ITEM	CODE	EQUIPMENT	DESCRIPTION	MANUFACTURER	CATALOG NO.	QTY.
1	BP		BOOSTER PUMP- PENTAIR WHISPERFLO - 3 HP	PENTAIR	WFE-12	1
2	FP		FILTER PUMP- PENTAIR WHISPERFLO - 1-1/2 HP	PENTAIR	WFE-6	1
3	F		FILTER AND INFLUENT PRESSURE GAUGE Clean & Clear Model	PENTAIR	CCP-320	1
4	H		RAYPAK NATURAL GAS HEATER LOW NOX ASME 399 BTU -110V	RAYPAK	C-R407A-EN-X-010230	1
5	CPAN		CONTROL PANEL- PENTAIR LX 802L Commercial Pool and Spa automatic control system - 115/230 Volt	PENTAIR	LX 802L	1
6	ws		1" POTABLE WATER SUPPLY w/ 1" Zurn Wilkins Backflow Preventer	Zurn Wilkins	1-975XL	1
7	CP		CHEMICAL PUMPS- STENNER MODEL 45M2 - 10 GPD	STENNER	45M2	2
8	CC		CHEMICAL CONTROL- Pentair Intellichem	PENTAIR	521357	1
9	CCT		CHEMICAL CONTAINMENT TANKS - Pentair Intellichem, Chlorine model 521397 and Acid model 521378	PENTAIR	521397 521378	2
10	CTK		CHEMICAL TEST KIT - TAYLOR MODEL-K2000, DPD, PH	TAYLOR	K2000	1
11	FM		FLOWMETER - BLUE WHITE MODEL F-300 FOR 2" PVC	BLUE WHITE	F-300	1
12	VG		VACUUM GAUGE	-	-	2

APPROVED

NOTES:

- All Equipment wired to Control Panel and then to Pool Panel
- All breakers to be GFI - use Siemens Breakers
- Bonding by Electrician - #8 Bare
- Nespa installs Rail Bonds & Pool Bond
- Equipment & Tanks Seismically Restrained

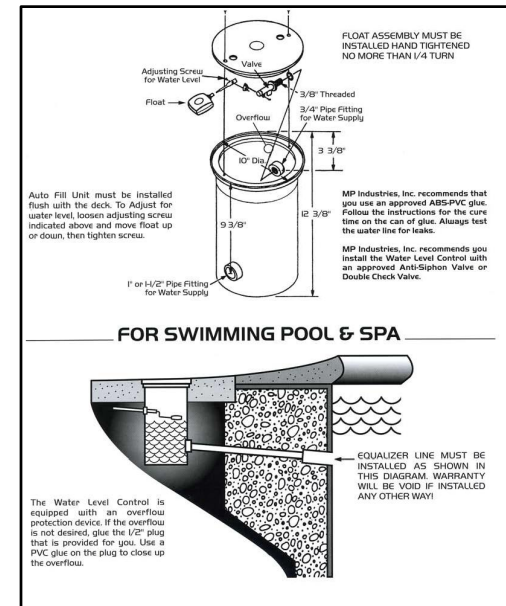
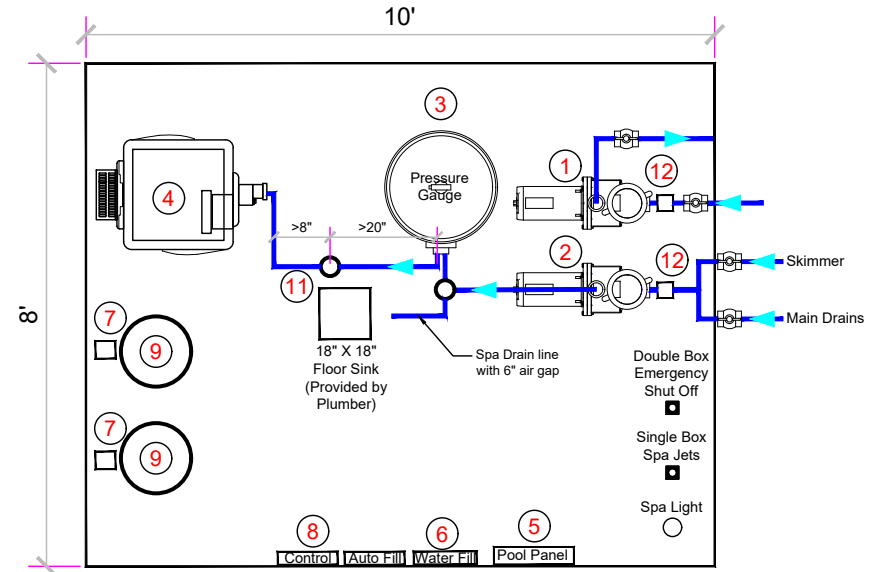

These drawings, concepts, and details contained herein are the original proprietary designs of **NESPA ENTERPRISES INC.**, developed over many years of experience in the industry and as such are protected by the copyright laws of the United States Government. Reproduction of any of the above without written permission to do so by **NESPA ENTERPRISES INC.**, is illegal.

NESPA ENTERPRISES INC.
 2800 Richter Ave. Ste. C Oroville, CA 95966
 Office: (530) 534-9910 Fax: (530) 534-9915
 E-Mail: jim@tiledspas.com Web Site: www.tiledspas.com



If printing as a PDF:

Page Scaling:

DWG NAME

SCALE
N/A

G-8

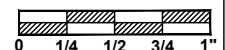

DATE
6/21/2018

DWG TYPE
EQ Layout
SHEET
PAGE 6 OF 9

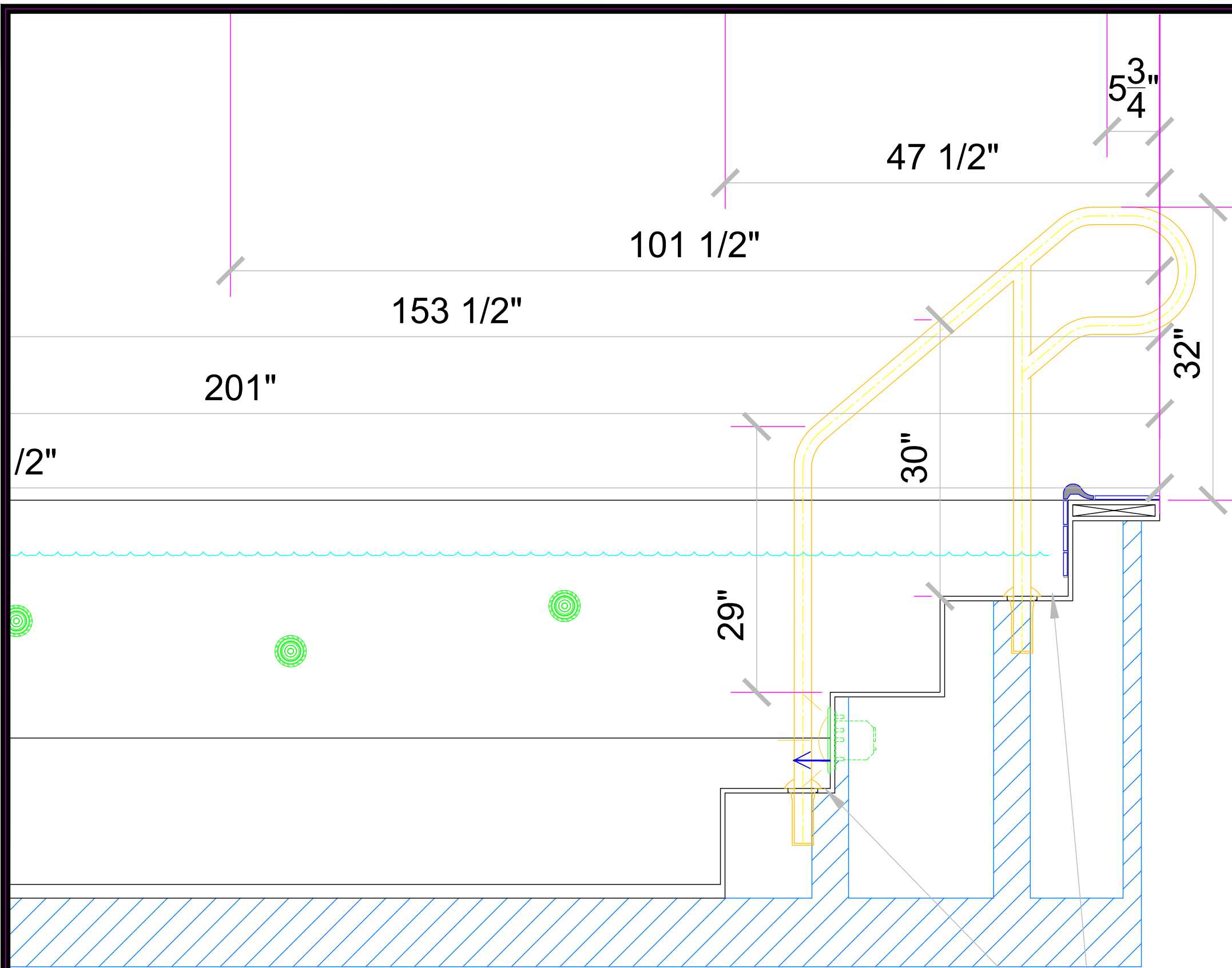

Waterproof Skid Support Structure attached to spa at Nespa factory

Location of cup anchors not to exceed 3" away from vertical riser wall

APPROVED

These drawings, concepts, and details contained herein are the original proprietary designs of **NESPA ENTERPRISES INC.**, developed over many years of experience in the industry and as such are protected by the copyright laws of the United States Government. Reproduction of any of the above without written permission to do so by **NESPA ENTERPRISES INC.**, is illegal.

NESPA ENTERPRISES INC.
 2800 Richter Ave. Ste. C Oroville, CA 95966
 Office: (530) 534-9910 Fax: (530) 534-9915
 E-Mail: jim@tiledspas.com Web Site: www.tiledspas.com



If printing as a PDF:
 Page Scaling:
 DWG NAME
 G-8

SCALE
 1" = 1'

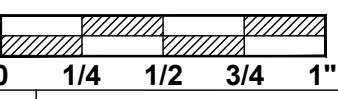

DATE
 6/21/2018

DWG TYPE
 Handrail
 SHEET
 PAGE 7 OF 9

BONDING DETAIL



Typical Cup Anchor

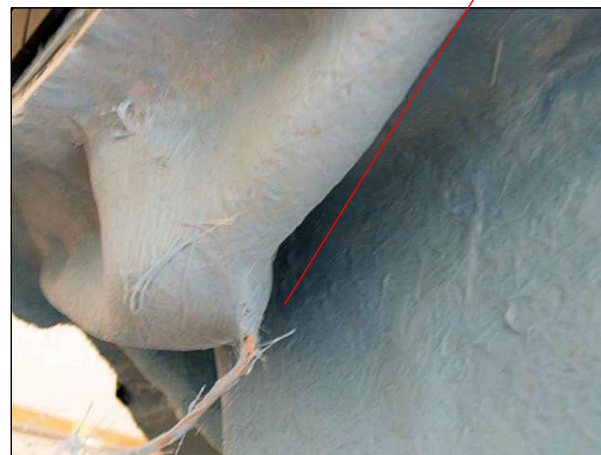
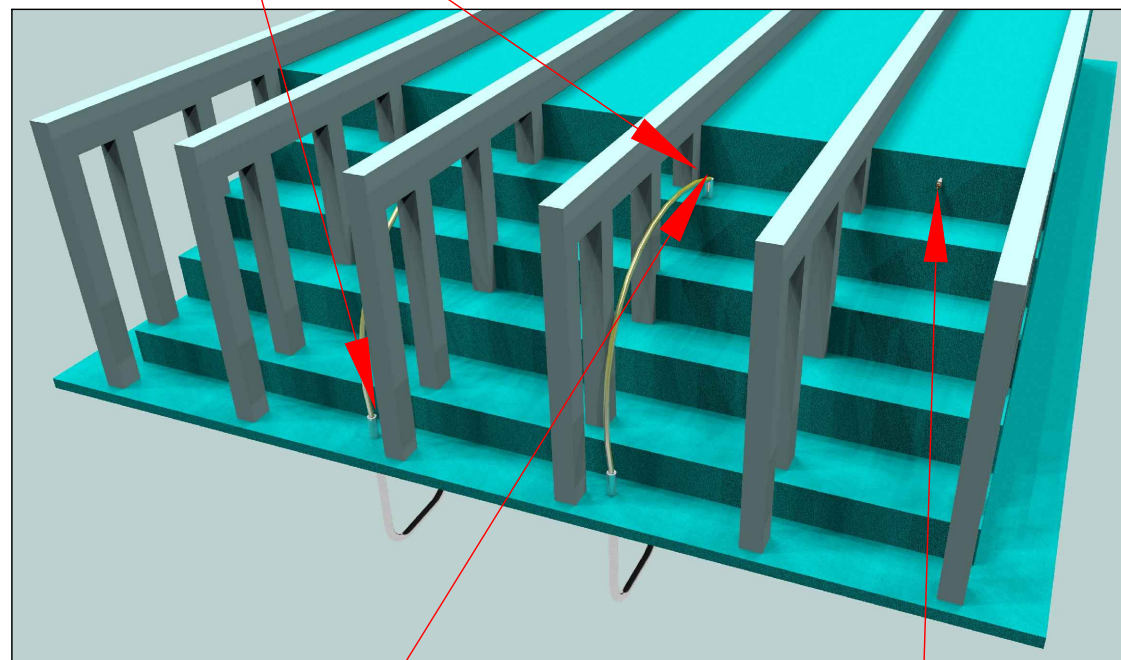
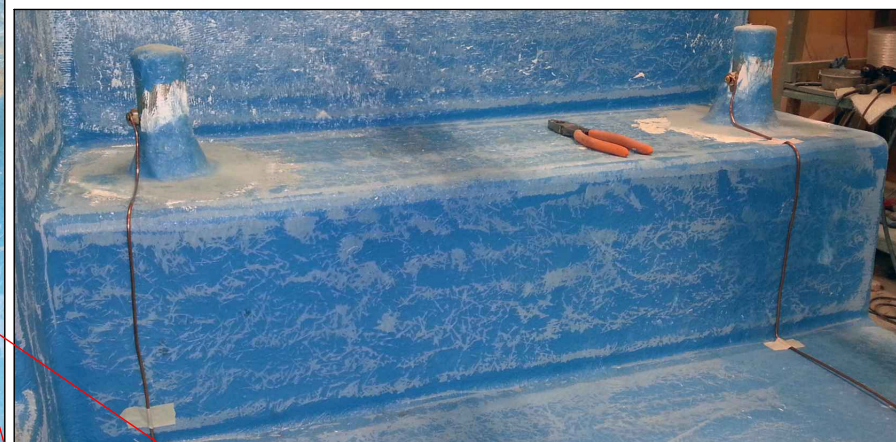

APPROVED

TYPICAL NESPA SHELL CUP Anchor Installation

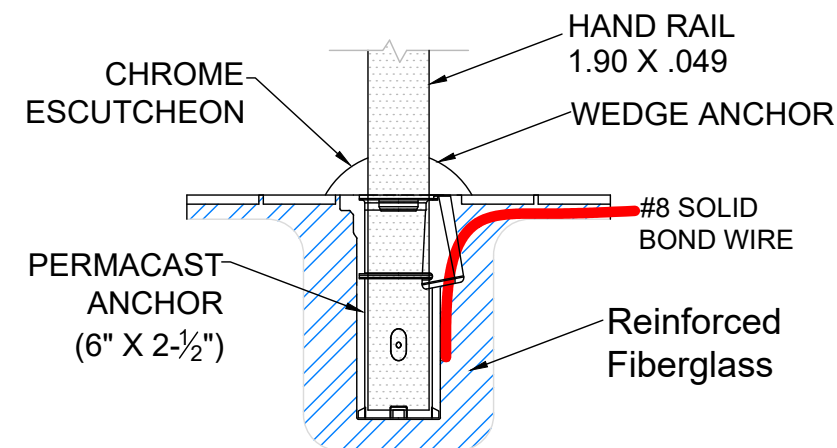

NOTE:

DETAIL REFLECTS ANCHOR INSTALLATION IN NESPA SHELLS ONLY.

CUP ANCHOR SHALL BE BONDED WITH A SOLID #8 COPPER BOND WIRE AND VERIFIED BY A CALIFORNIA LICENSED ELECTRICAL CONTRACTOR.

BOND WIRE WILL BE ENCASED AND COVERED IN FIBERGLASS TO PREVENT WATER LEAKAGE THRU SHELL.

BOND WIRE SHALL EXIT AT EDGE OF SPA AND ATTACH TO DECK BONDING GRID.

1 Anchor Detail

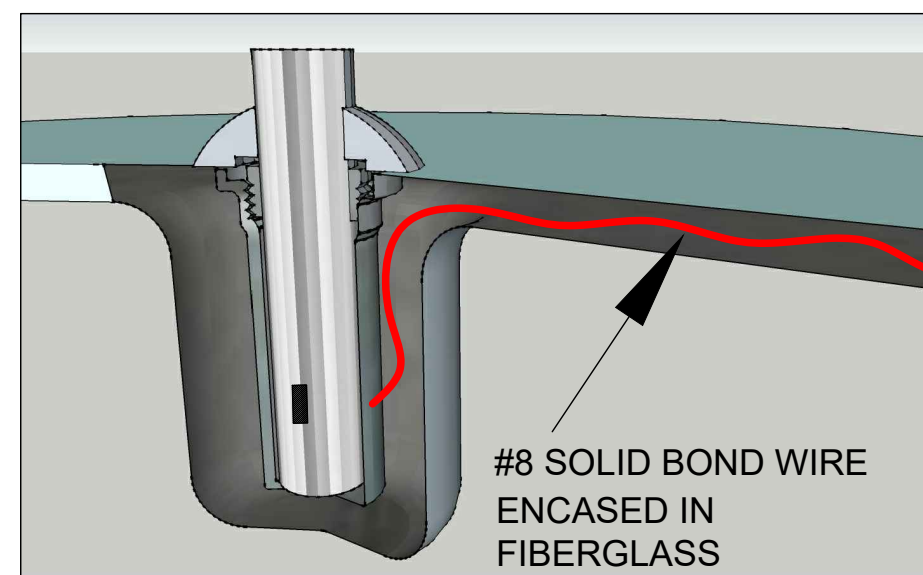

PS-6019-BC 6 Inch Big Boy Socket

Parts List	
QTY	Description
1	PS-6019-BC Socket Bronze
1	PW-4C Wedge
1	Stainless Steel Washer
1	5/16-18 X 1-3/4" SS Bolt
1	10-24 X 3/8" Brass Screw

- 6" Deep Socket
- Accommodates 1.90" OD Tubing
- Uses PW-4C Wedge
- Includes Wedge, Washer, Bolt and Bonding Screw

POOLBOND

By Perma-Cast

THE 2008 NATIONAL ELECTRICAL CODE (NEC) REQUIRES THAT AN INTENTIONAL ELECTRICAL BOND BE MADE TO THE POOL WATER. THIS REQUIREMENT IS SPELLED OUT IN SECTION 680.26(C) OF THE NEC. THIS REQUIREMENT COVERS BOTH INGROUND AND ABOVE GROUND POOLS, SPAS, AND FOUNTAINS.

PASS ELECTRICAL INSPECTION WITH POOLBOND

POOLBOND PB-2008

- PREMIUM CORROSION RESISTANT BRONZE CASTING
- 1" MALE PIPE THREADS PROVIDES DIRECT INSTALLATION TO YOUR POOL, SPA, AND FOUNTAIN PLUMBING
- 10.5 SQUARE INCHES OF SURFACE AREA CONTACTS THE POOL WATER
- SPLIT BOLT LUG PROVIDES EASY & RELIABLE CONNECTION TO BONDING WIRE

ACTUAL SIZE

UL LISTED 40YZ

Available Through Distribution Nationwide

1871 Aspen Circle • Pueblo, Colorado 81008 • Phone 800-748-2770 • Fax 719-544-3106
Visit Us At www.permacastonline.com

These drawings, concepts, and details contained herein are the original proprietary designs of **NESPA ENTERPRISES INC.**, developed over many years of experience in the industry and as such are protected by the copyright laws of the United States Government. Reproduction of any of the above without written permission to do so by **NESPA ENTERPRISES INC.**, is illegal.

NESPA ENTERPRISES INC.
2800 Richter Ave. Ste. C Oroville, CA 95966
Office: (530) 534-9910 Fax: (530) 534-9915
E-Mail: jim@tiledspas.com Web Site: www.tiledspas.com



If printing as a PDF:

Page Scaling: None

DWG NAME

G-8

SCALE
N/A

DATE
6/21/2018

DWG TYPE
Bonding Detail

SHEET
PAGE 8 OF 9

POOL BONDING REQUIREMENTS:

1. THE FOLLOWING PARTS SHALL BE BONDED TOGETHER AND CONNECTED TO THE COMMON BONDING GRID.
 - A. ALL THE METALLIC PARTS OF THE POOL STRUCTURE INCLUDING COPPING STONES, DECK, PERMANENT PLAY STRUCTURES, PERMANENT EXERCISE STRUCTURES.
 - B. ALL METAL FITTINGS WITHIN OR ATTACHED TO THE POOL STRUCTURE
 - C. METAL PARTS ASSOCIATED WITH THE POOL WATER CIRCULATING SYSTEM, INCLUDING PUMPS, FILTERS, AND HEATERS.
 - D. METAL PARTS ASSOCIATED WITH POOL COVERS
 - E. METAL SHEATHED CABLES AND RACEWAYS, METAL PIPING AND ALL FIXED METAL PARTS WITHIN 5 FEET HORIZONTALLY OF INSIDE WALLS OF POOL AND WITHIN 12 FEET ABOVE MAXIMUM WATER LEVEL OF POOL.
 - F. METAL PARTS ASSOCIATED WITH OBSERVATION STANDS, TOWERS, PLATFORMS, AND DIVING STRUCTURES.
2. BONDING CONDUCTORS SHALL BE MINIMUM #8 SOLID COPPER, INSULATED E.C. SHALL COORDINATE APPROVED CONNECTOR TYPE AND METHOD WITH LOCAL ELECTRICAL AND/ OR POOL INSPECTOR.
3. SPECIFIC MANUFACTURER'S INSTRUCTIONS REGARDING BONDING OR GROUNDING OF POOL EQUIPMENT, WHETHER INDICATED HEREIN OR NOT, SHALL BE STRICTLY FOLLOWED.
4. THE COMMON BONDING GRID SHALL NOT BE CONNECTED TO ANY ELECTRICAL DISTRIBUTION EQUIPMENT.
5. ANY PARTS IN ADDITION TO THOSE DESCRIBED HEREIN THAT ARE INDICATED BY POOL CONTRACTOR OR LOCAL INSPECTION AUTHORITY SHALL BE BONDED TO THE COMMON BONDING GRID WITH NO ADDITIONAL COSTS INCURRED BY THE OWNER.
6. THE ELECTRICAL CONTRACTOR SHALL COORDINATE BONDING WITH GENERAL CONTRACTOR.

LIGHT DETAIL

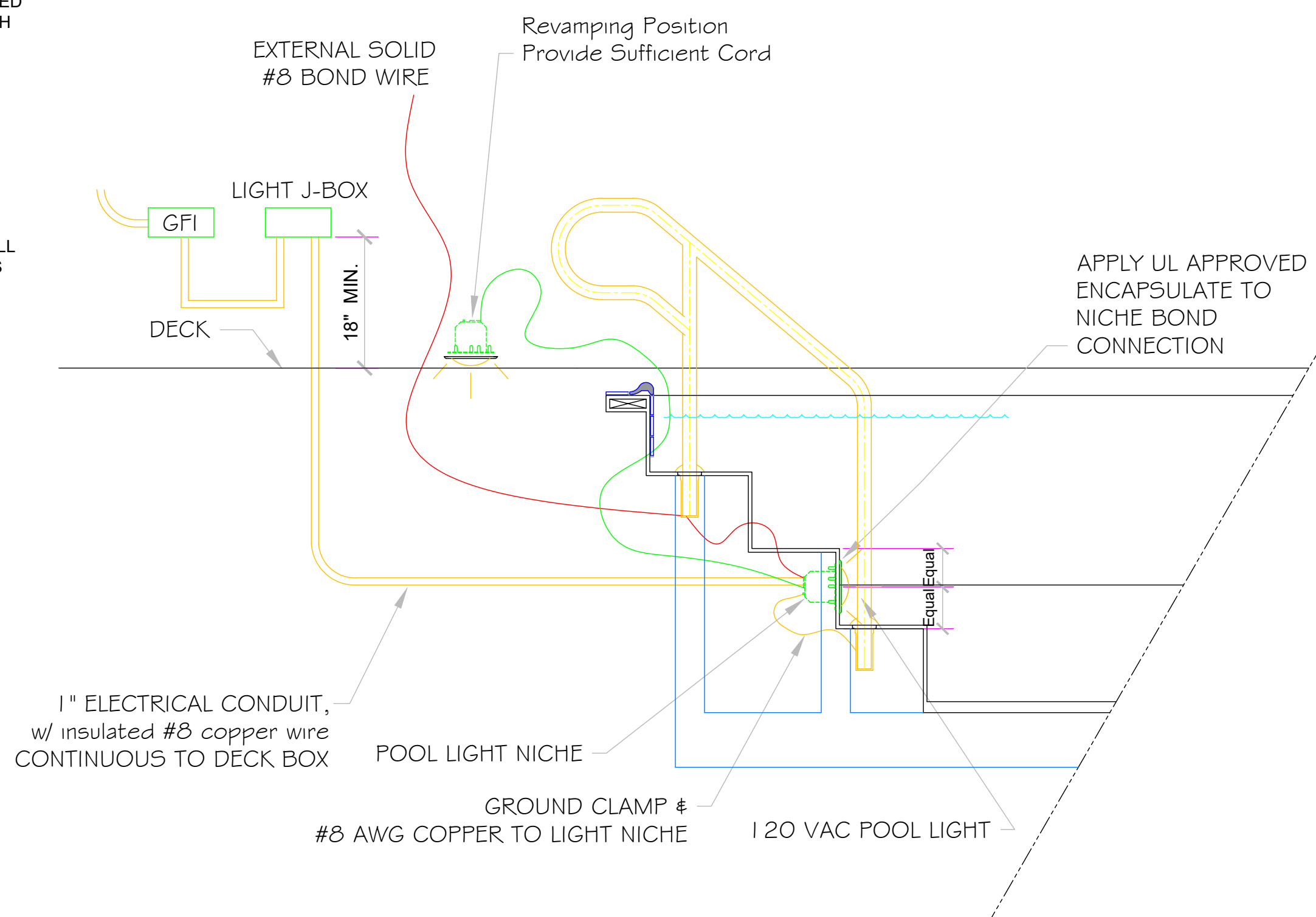

APPROVED

These drawings, concepts, and details contained herein are the original proprietary designs of **NESPA ENTERPRISES INC.**, developed over many years of experience in the industry and as such are protected by the copyright laws of the United States Government. Reproduction of any of the above without written permission to do so by **NESPA ENTERPRISES INC.**, is illegal.

NESPA ENTERPRISES INC.
 2800 Richter Ave. Ste. C Oroville, CA 95966
 Office: (530) 534-9910 Fax: (530) 534-9915
 E-Mail: jim@tiledspas.com Web Site: www.tiledspas.com



If printing as a PDF:

Page Scaling:

DWG NAME

G-8

SCALE
 3/4" = 1'



DATE

6/21/2018

DWG TYPE

Light Detail

SHEET

PAGE 9 OF 9



2" Skimmer Suction

2-1/2" Filter Return

1" Light Conduit

3" Filter Suction

Bond

2" Air Venturi

3" Booster Return

3" Filter Suction

4" Booster Suction

APPROVED

These drawings, concepts, and details contained herein are the original proprietary designs of **NESPA ENTERPRISES INC.**, developed over many years of experience in the industry and as such are protected by the copyright laws of the United States Government. Reproduction of any of the above without written permission to do so by **NESPA ENTERPRISES INC.**, is illegal.

NESPA ENTERPRISES INC.
 2800 Richter Ave. Ste. C Oroville, CA 95966
 Office: (530) 534-9910 Fax: (530) 534-9915
 E-Mail: jim@tiledspas.com Web Site: www.tiledspas.com

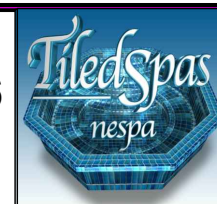

If printing as a PDF:

Page Scaling:

DWG NAME

G-8

SCALE

1 101/256" = 1"

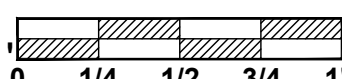

DATE

10/18/2018

DWG TYPE

Plumbing ID

SHEET

PAGE 1 OF 1

STANDARD NESPA IN-GROUND INSTALLATION *INSTRUCTIONS* **SET-UP AND EXCAVATION**

Prerequisites: Before installing your Nespa spa. You may be required to acquire a permit from your local State, County, and City building dept and or Health department. (Commercial jobs need Health Dept. Approval). Your spa installation must comply with the most current codes. (**Uniform Swimming Pool, Spas & Hot Tub Code 2006 (USPC 2006)**).

Spa drawings: Request from Nespa a current spa specific construction detail, plan and section, spa plumbing detail.

Delivery Access: Clearly determine the method of getting the spa to jobsite and into the hole. This may require the use of a crane, forklift, hoist, backhoe and/or manpower etc.

- 1) The following instructions are general guidelines and may not apply to your specific jobsite conditions. When excavating for your spa remember to provide for plumbing and light connection clearances. In order to determine how to excavate for your spa or swim spa, measure spas outside dimension (O.D.) and add minimum 3" to all sides. This 3" clearance is to accommodate jet and suction plumbing. This 3" clearance can change or be reduced upon request. Note: skimmer location, this area may have to be larger than 3", if commercial 22".
- 2) **Freeze Climates-** If the spa is placed into a vault (typical of freeze climates) a standard 18" or more of clearance minimum from spa perimeter should be provided. This dead air space is for possible future access to spa plumbing in case of a freeze. Area drain is mandatory. **Ask your local installer** for his experienced opinion. Do not hesitate to call us because we want to be sure that your installation progresses as smoothly as possible. If you have questions call us. (888) 479-4677.
- 2) **Hole depth** is determined by spa's outside height dimension. This height may vary depending if spa has skids or no skids. The spa lip may be finished or non-finished. How is the perimeter deck elevation transitioning to the spa? Focus on the finish surrounding deck elevations, thickness of the finish material on spa upper horizontal lip, equal to lip or under the spa lip. This material can be tile, stone, concrete or brick.
- 3) **Preplumb** the spa before it goes into the hole. If there are needs for electrical, bonding or control conduits run them as well before dropping in hole. Connect bond wire to niche would be best.
- 4) **Spa should sit on level 3 ½" thick reinforced concrete pad. Sweep debris off pad prior to dropping in hole.**
- 5) **Install spa** into the hole on top of concrete pad. Use the Eye bolts provided for crane, forklift etc. rigging. Do not hold onto pipes. Use caution with suction and jet plumbing when lowering into hole. **DO NOT STRESS FITTINGS!** Fill Spa with water and check for leaks prior to backfill.

- 6) **Check site reference** points for proper spa positioning (i.e., squaring to house, garage, etc.).
- 7) **Shim to level spa.** Shim with non-compression able material. Re square to house, or ref. point.
- 8) **Dry pack** with cement the gaps that have been created when shimming spa level.
- 9) **Connect pipes to tees** if spa is preplumb. Installers properly support your new plumbing from stressing spas preplumb fittings. After electrical conduit and bond wire is connected to light niche, water test spa before back filling with sand.
NOTE: All Nespa products are water tested prior to leaving factory.

ELECTRICAL:

- 1) All electrical connections to spa or equipment should comply with the most recent national electrical code (NEC), state and local codes.
- 2) Connect electrical conduit to light niche. This work should be done or reviewed by a licensed electrician.
- 3) To install spa light you will need to include inside the PVC conduit to the light niche a solid #8 coated copper wire. (If you are use brass conduit, internal bond wire is not required.) This bond wire should be pulled with the light cord at the same time. This bond wire needs to be attached to the internal bonding lug of the light niche. An approved encapsulate should be applied to bond wire connection in niche.
- 4) An external #8 copper wire shall be connected to the external bonding lug on the rear of the light niche. This copper wire can then be used for additional bonding requirements (i.e., handrails or any other metallic object within 5' of the spa.

PLUMBING:

- 1) **When plumbing a Nespa it is important to properly size the plumbing. We highly recommend that you follow the pump manufacturer's pipe sizing requirements and Uniform Swimming Pool, Spas & Hot Tub Code 2006 (USPC 2006). This code book is available at www.IAPMO.org or (909) 472 4100.**
- 2) The jet air venturi should be a Hartford loop design adjacent to spa shell and air entry point can be located next to spa or remotely at equipment.
- 3) Fill spa with water and test the system for leaks PRIOR to backfilling with sand.

SAND BACK FILL:

- 1) **With water in spa, back-fill around spa perimeter with dry plaster sand and wet wash with hydraulic attachment to hose. Let set for one hour and hydraulic dry again. Be sure water level in spa is at the highest level. Any questions please call us. (888) 479-4677.**
- 2) **If spa is free standing on elevated deck or a structure, it is important to fill spa with water and load area prior to installing coping or perimeter decking. If spa is installed in a vault situation a area drain is needed.**

NESPA ENTERPRISES INC.

2800 Richter Ave. Suite E

Oroville, CA 95966

Office: (888) 479-4677 Fax: (530) 534-9915

E-Mail: nespa@pacbell.net www.tiledspas.com

IN-GROUND

INSTALLATION

ALL DIMENSIONS SUBJECT TO 1/4" TOLERANCES

SCALE: 1/2" = 1'-0"

DATE: 3/27/02

JOB : STANDARD INSTALL

DW #: SI-1, SI-2

NOTE:

Sump pump or gravity drain is required for removing water from vault

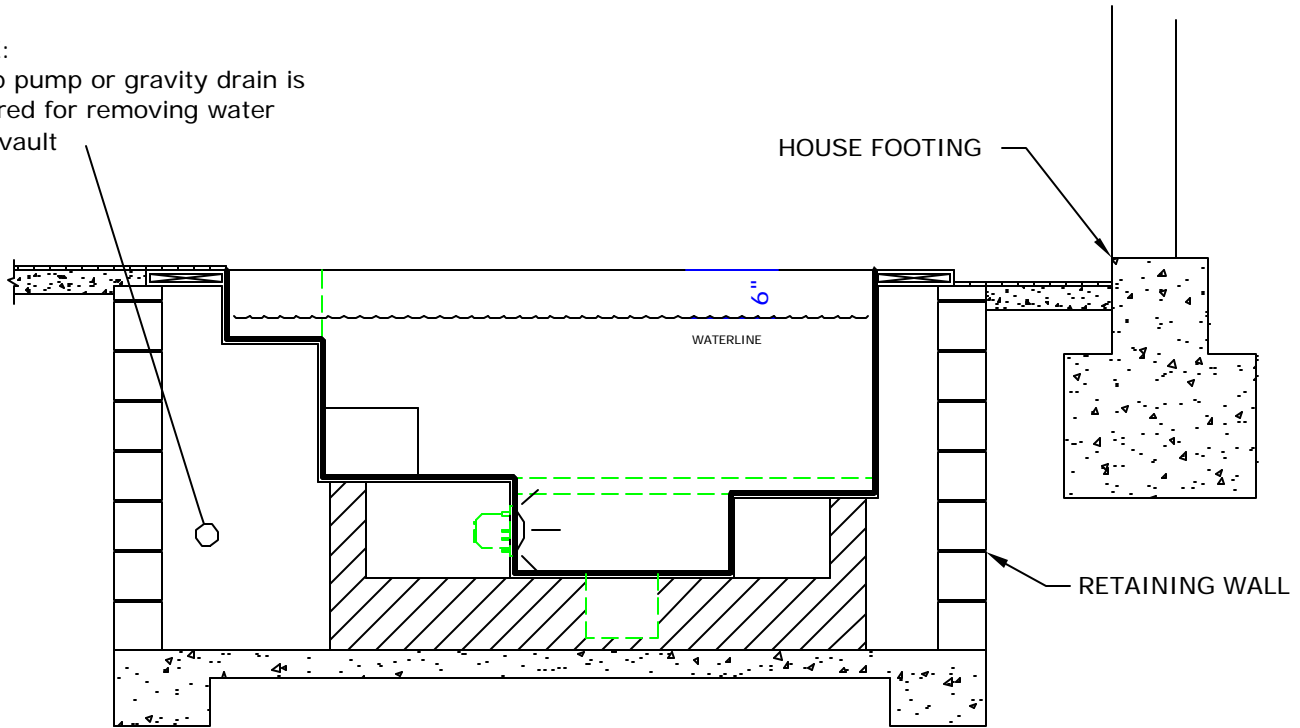

STANDARD VAULT INSTALLATION

SI-1

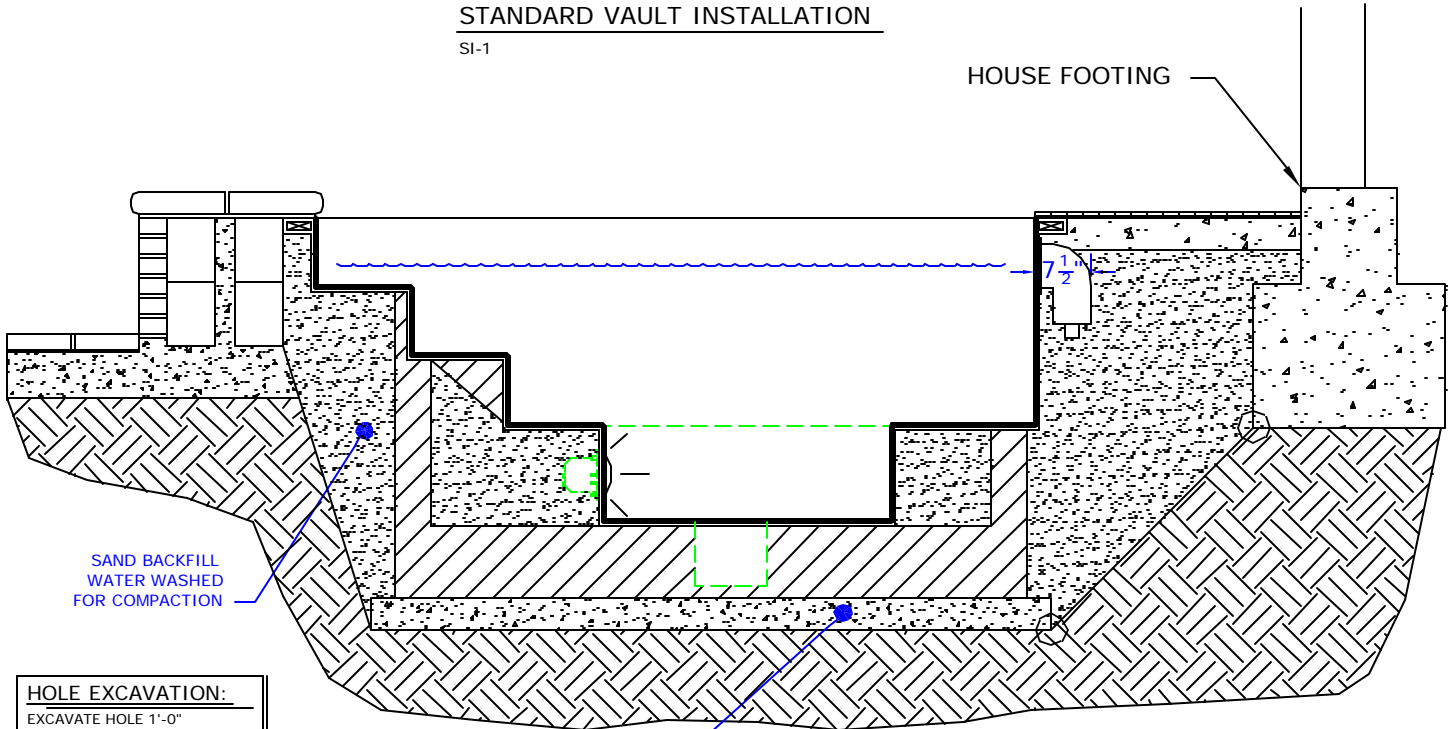

HOLE EXCAVATION:

EXCAVATE HOLE 1'-0" LARGER THAN THE OUTSIDE DIAMETER (OD) OF SPA

4" CONCRETE SLAB REINFORCED WITH #10 MESH

STANDARD INGROUND INSTALLATION

SI-2

NOTE:

Footing can not surcharge spa. Slope from bottom of slab to nearest corner of house footing must not exceed 1" = 1".

POOL BONDING REQUIREMENTS:

1. THE FOLLOWING PARTS SHALL BE BONDED TOGETHER AND CONNECTED TO THE COMMON BONDING GRID.
 - A. ALL THE METALLIC PARTS OF THE POOL STRUCTURE INCLUDING COPING STONES, DECK, PERMANENT PLAY STRUCTURES, PERMANENT EXERCISE STRUCTURES.
 - B. ALL METAL FITTINGS WITHIN OR ATTACHED TO THE POOL STRUCTURE
 - C. METAL PARTS ASSOCIATED WITH THE POOL WATER CIRCULATING SYSTEM, INCLUDING PUMPS, FILTERS, AND HEATERS.
 - D. METAL PARTS ASSOCIATED WITH POOL COVERS
 - E. METAL SHEATHED CABLES AND RACEWAYS, METAL PIPING AND ALL FIXED METAL PARTS WITHIN 5 FEET HORIZONTALLY OF INSIDE WALLS OF POOL AND WITHIN 12 FEET ABOVE MAXIMUM WATER LEVEL OF POOL.
 - F. METAL PARTS ASSOCIATED WITH OBSERVATION STANDS, TOWERS, PLATFORMS, AND DIVING STRUCTURES.
2. BONDING CONDUCTORS SHALL BE MINIMUM #8 SOLID COPPER, INSULATED E.C. SHALL COORDINATE APPROVED CONNECTOR TYPE AND METHOD WITH LOCAL ELECTRICAL AND/ OR POOL INSPECTOR.
3. SPECIFIC MANUFACTURER'S INSTRUCTIONS REGARDING BONDING OR GROUNDING OF POOL EQUIPMENT, WHETHER INDICATED HEREIN OR NOT, SHALL BE STRICTLY FOLLOWED.
4. THE COMMON BONDING GRID SHALL NOT BE CONNECTED TO ANY ELECTRICAL DISTRIBUTION EQUIPMENT.
5. ANY PARTS IN ADDITION TO THOSE DESCRIBED HEREIN THAT ARE INDICATED BY POOL CONTRACTOR OR LOCAL INSPECTION AUTHORITY SHALL BE BONDED TO THE COMMON BONDING GRID WITH NO ADDITIONAL COSTS INCURRED BY THE OWNER.
6. THE ELECTRICAL CONTRACTOR SHALL COORDINATE BONDING WITH GENERAL CONTRACTOR.

LIGHT DETAIL

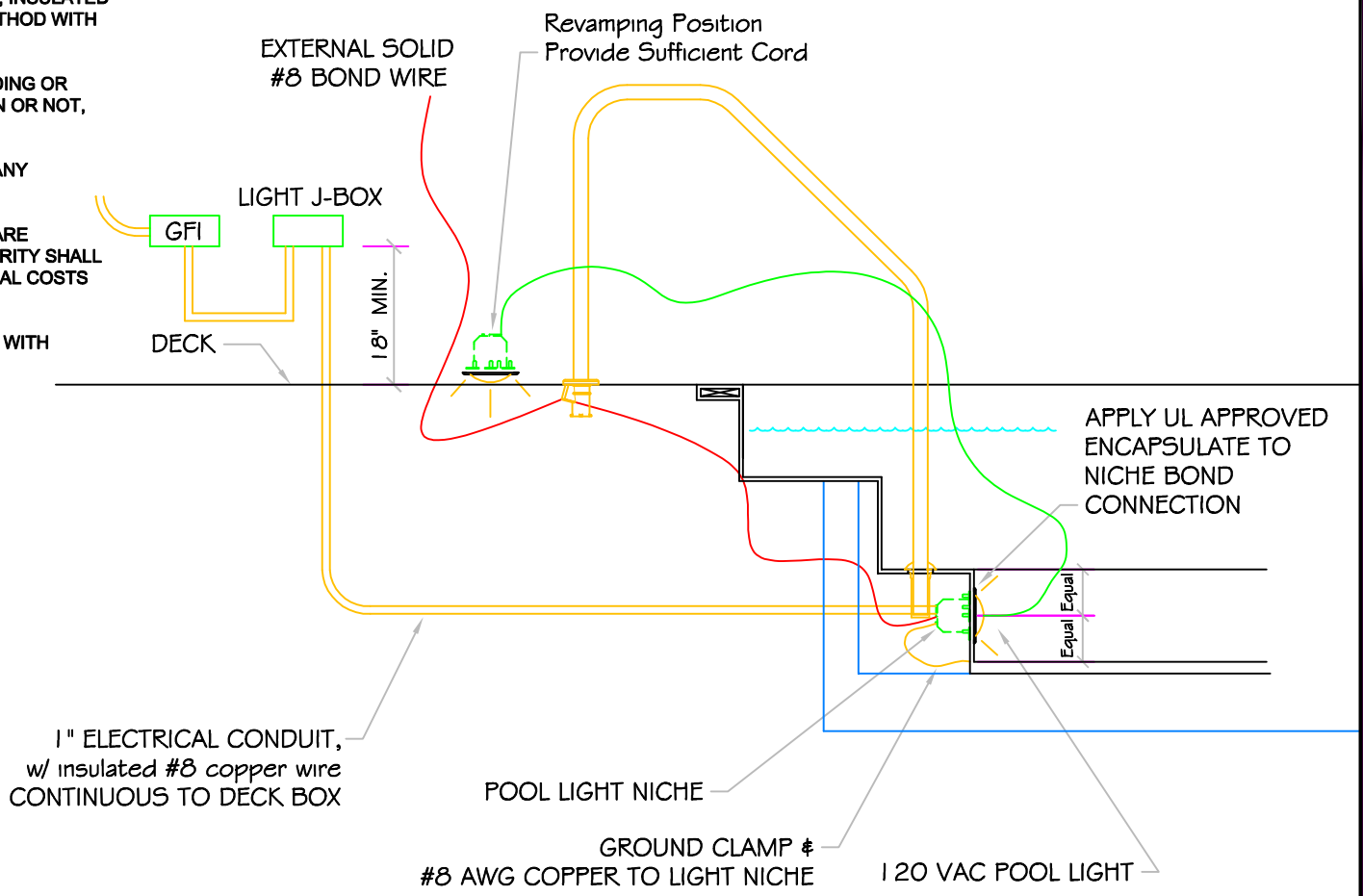

ALL DIMENSIONS SUBJECT TO 1/4" TOLERANCES

These drawings, concepts, and details contained herein are the original proprietary designs of NESPA ENTERPRISES, developed over many years of experience in the pool and spa industry and as such are protected by the copyright laws of the United States Government. Reproduction of any of the above without written permission to do so by NESPA ENTERPRISES, is illegal.

NESPA ENTERPRISES INC.
 2800 Richter Ave. Ste. C Oroville, CA 95966
 Office: (530) 534-9910 Fax: (530) 534-9915
 E-Mail: sales@tiledspas.com Web Site: www.tiledspas.com



SIZE A	DWG NAME DETAILS	DWG TYPE Detail
SCALE 1/2" = 1'	DATE 7/24/2008	SHEET PAGE 1 OF 1

NESPA ENTERPRISES, Inc. LIMITED WARRANTY

This LIMITED WARRANTY covering NESPA products is extended to the ORIGINAL PURCHASER-USER BY NESPA ENTERPRISES Inc.(NESPA), 2800 Richter Ave. Unit C California 95966.

NESPA products are thoroughly inspected and tested prior to factory shipment. NESPA warrants to the ORIGINAL PURCHASER-USER that NESPA Spas and Swim Spas will be free of defect in workmanship, accessories and parts, provided said accessories and parts were manufactured by NESPA. NESPA, under this LIMITED WARRANTY, warrants only that its Spas and Swim Spas shall be structurally sound, shall retain their shape, and shall retain water for the warranty period. NESPA warrants the adhesion of tile to fiberglass for a period of three (3) years and structural soundness for ten (10) years. NESPA warrants epoxy grout adhesion for a period of three years. If any such defects appear and are reported within the warranty period, NESPA shall repair or replace such defective parts without charge if an inspection proves the claim.

The provisions of the LIMITED WARRANTY shall not apply to tile cracked, split, chipped or damaged after the product has left the factory, nor damage to tile caused by freezing nor to damage, defect, malfunction or failure to conform with the above warranty provisions where the damage, defect, malfunction or failure to conform was caused during shipment or by distributor or by unreasonable use by ORIGINAL PURCHASER-USER including improper water balance and improper sand pack or support.

This LIMITED WARRANTY shall not apply to any plumbing, equipment, or installation of spas and Swim Spas and shall not apply to any alterations made to or upon NESPA products except alterations made by NESPA employees or NESPA authorized representatives.

This LIMITED WARRANTY is expressly in lieu of all other warranties expressed or implied including the warranties of merchantability and fitness for use and all other obligations or liabilities on NESPA'S part, and NESPA neither assumes nor authorizes any other person to assume for NESPA any other liability in connection with the sale of this NESPA product. This LIMITED WARRANTY shall not apply to this NESPA product or any part thereof which has been subject to accident, negligence, alteration, abuse or misuse. NESPA makes no warranty whatsoever with respect to accessories or parts not manufactured by NESPA.

The term "ORIGINAL PURCHASER-USER" as used in this LIMITED WARRANTY shall be deemed to mean that person for whom the NESPA product is originally installed.

The LIMITED WARRANTY provided herein and the obligations and liabilities of NESPA hereunder are exclusive and are in lieu of, and buyer and original PURCHASE-USER hereby waive all other remedies, warranties, guarantees or liabilities, expressed or implied, arising by law or otherwise (including without limitation and obligations of NESPA with respect to fitness, merchantability, and consequential damages) or whether or not occasioned by NESPA'S negligence.

This LIMITED WARRANTY shall not be extended, altered or varied except by a written instrument signed by NESPA and original PURCHASER-USER.