



NESPA
TILED SPAS

Production Booklet

for

**GOLD TEX
SPA and POOL**

2800 Richter Ave. Suite C, Oroville, CA 95965 • **voice:** (530)534-9910
fax: (530)534-9915 • **email:** sales@tiledspas.com • **website:** www.tiledspas.com



RECOMMENDED MAINTENANCE

Please Note:

These are only recommended guidelines to care for a Nespa all tiled spa. Local codes may require additional procedures, therefore consult with a pool professional that is LA county Health Department certified for more information on local codes and requirements.

SPA SURFACE

Your spa tile is acid resistant and frost-proof. The Tile does not absorb germs or algae. Tile does not stain and is very easy to clean. Color does not fade or lose its luster. All grouts are epoxy based and are extremely durable. To remove scum line use soft nylon brush and small amounts of biodegradable soaps. Do not use abrasive brushes or chemicals.

MAINTENANCE

A. CHEMICALS:

- 1) It is important to maintain a chlorine residual of 2 PPM in the spa. That residual can be provided by chlorine or bromine.
- 2) It is recommended to use Bromine or dichlor (granular) forms of chlorine. If bromine Tabs are used we suggest floating or inline dispenser.
- 3) Never use acid to lower Ph in the tile spa.
- 4) Never use trichlor chlorine (1" or 3") tablets in the Nespa spas.
- 5) Never place tablets in skimmer basket.

B. DRAINING THE SPA:

- 1) It is recommended to drain the spa at least once every 2 months depending on bath load and water clarity.
- 2) The spa should be drained through valve exiting re-circulation pump in the spa equipment room or sump pump.
- 3) Note: Use caution to drain spa in the winter months or rainy season when water table is at its highest. It is possible for the spa to float due to hydraulic pressure from surrounding water table. We advise that you consult with your local spa specialist prior to draining the spa.

C. SPA EQUIPMENT:

- 1) Clean filter cartridge at least once every month, or when needed; i.e., if water clarity does not improve after several days.
- 2) Keep area free and clear from leaves and debris build-up.
- 3) Keep area free and clear from flooding.

D. SPA LIGHT:

- 1) Spa light has to be on GFCI circuit. It is controlled at spa side with ON/OFF.

E. TILE SERVICING:

- 1) Contact manufacture when servicing tile or grout. @ (530) 534-9910

SPECIFICATIONS	
SHELL WEIGHT	2700 LBS.
WATER WEIGHT	10346 LBS.
TOTAL SHELL & WATER WEIGHT	13045.7 LBS.
WATER VOLUME	210 Cu.Ft.
MAX WATER GAL.	1571 GAL.
SURFACE AREA	99.0 SQ. FT.
IAPMO#	1138
FDA#	2030305

SKID SUPPORT STRUCTURE* BONDED TO SPA

*SKIDS SUPPLIED BY MFR.

LIGHT NICHE

 Nexus, 12 V, L.E.D., U.L. APPROVED

MAIN DRAIN

WATERWAY # 640-4700 V 9" X 9" FRAME, 39.9 sq. in. open area -
 Max Flow 289 GPM @ 2.33 fps (floor)
 Max Flow 198 GPM @ 1.59 fps (wall)
 COMPLIES W/ ANSI CODE ASME A112.19.8-07 U.L. APPROVED

SIDEWALL SUCTION

WATERWAY # 640-4700 V 9" X 9" FRAME, 39.9 sq. in. open area -
 Max Flow 289 GPM @ 2.33 fps (floor)
 Max Flow 198 GPM @ 1.59 fps (wall)
 COMPLIES W/ ANSI CODE ASME A112.19.8-07 U.L. APPROVED

EQUALIZER

5" HIGH FLOW SUCTIONS
 Waterway 640-357xV
 Super Hi-Flo Suction Assy.
 Max Flow 180 GPM
 COMPLIES W/ ANSI CODE ASME A112.19.8-2007 & VGB 2008

SKIMMER

HAYWARD SP-1084FVE SURFACE SKIMMER W/ EQUALIZER
 NSF APPROVED

JET

HYDRO INLETS
 1-1/2" WATER - 1-1/2" AIR
 HYDROAIR #10-5100
 COMPLIES W/ ANSI CODE ASME A112.19.8-07 U.L. APPROVED

RETURN

INLET FITTINGS
 1-1/2" WALL TYPE W/ EYEBALL
 HYDROAIR #10-3500
 COMPLIES W/ ANSI CODE ASME A112.19.8-07 U.L. APPROVED

FILL

INLET FITTINGS
 1-1/2" WALL TYPE W/ EYEBALL
 HYDROAIR #10-3500
 COMPLIES W/ ANSI CODE ASME A112.19.8-07 U.L. APPROVED

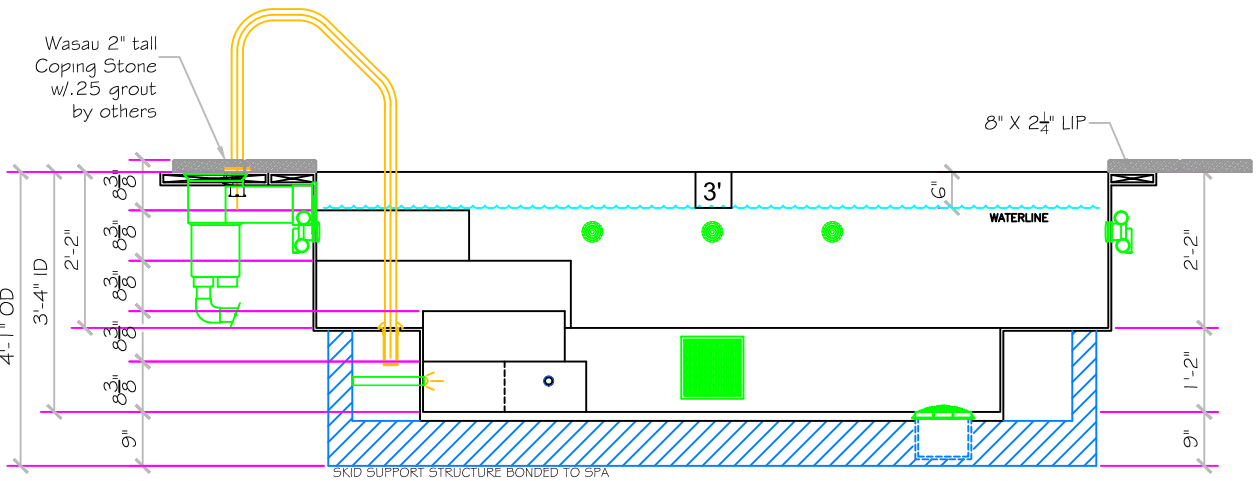
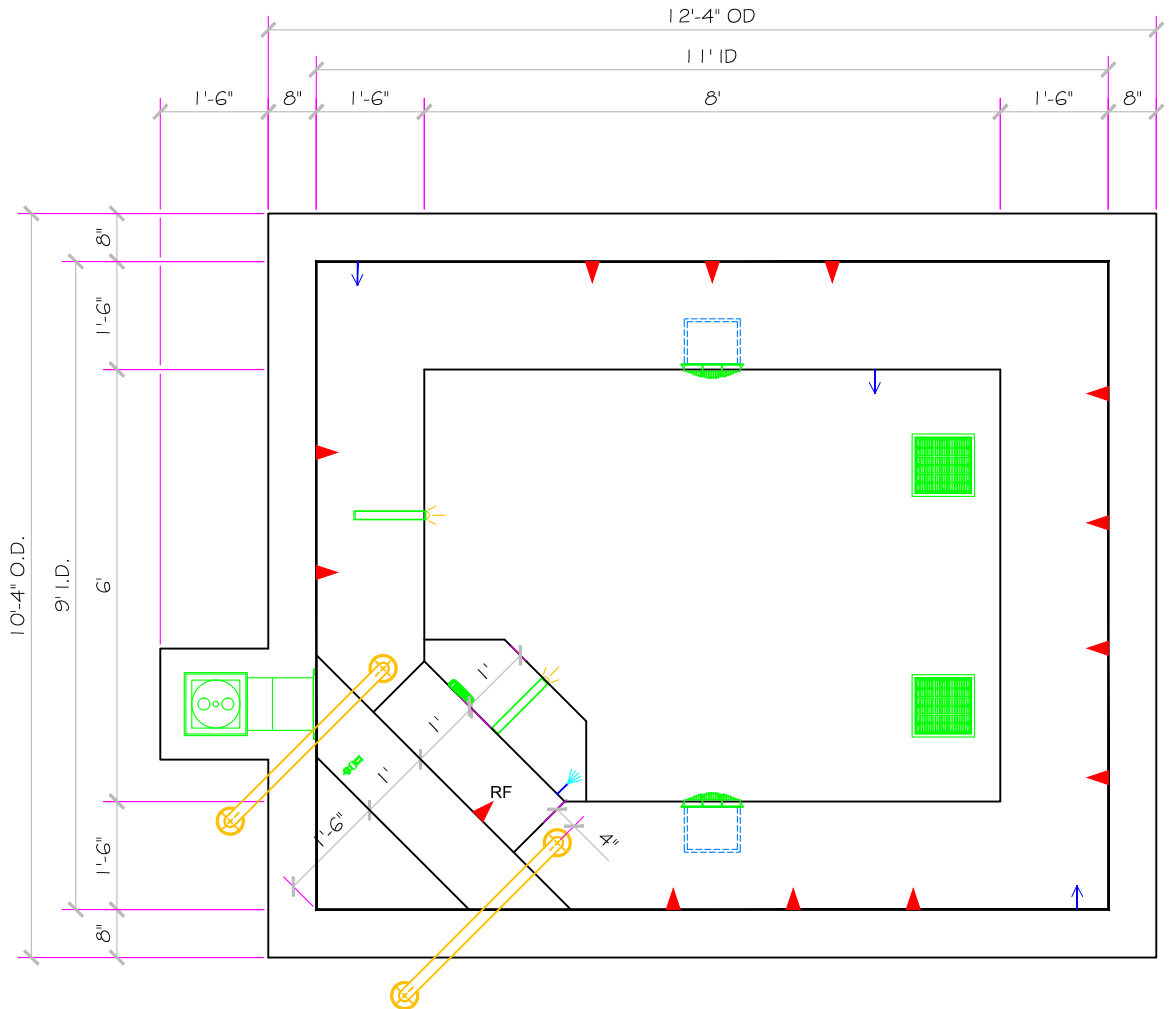

APPROVED

ALL DIMENSIONS SUBJECT TO 1/4" TOLERANCES

All drawing dimensions supplied by **MAINLINE Com Pools INC.** are for reference only. All CAD files were created using AutoCAD file (*.dwg.) and were provided as a service to our customers using AutoCAD. Errors sometimes occur during this process and with software incompatibility upon opening a file. **MAINLINE Com Pools INC.** and/or any authorized distributor of our products will not be held responsible for problems arising from files which have been converted and does not warranty the documents against deficiencies or typographical errors of any kind. We recommend that all measurements are verified with actual physical product before any custom fabrication in the field occurs.

MAINLINE - Commercial Pools, Inc.
 441 Fehely Dr. King of Prussia, PA 19406
 Phone: (610) 279-9285 Fax: (610) 277-4276
 E-Mail: info@mainlinepools.com



SCALE 3/8" = 1'		DWG TYPE SPA SD
DWG NAME GOLD TEX	DATE 7/6/2012	SHEET 1 OF 12

These drawings, concepts, and details contained herein are the original proprietary designs of **MAINLINE Com Pools, Inc.** developed over many years of experience in the industry and as such are protected by the copyright laws of the United States Government. Reproduction of any of the above without written permission to do so by **MAINLINE Com Pools, Inc.** is illegal.

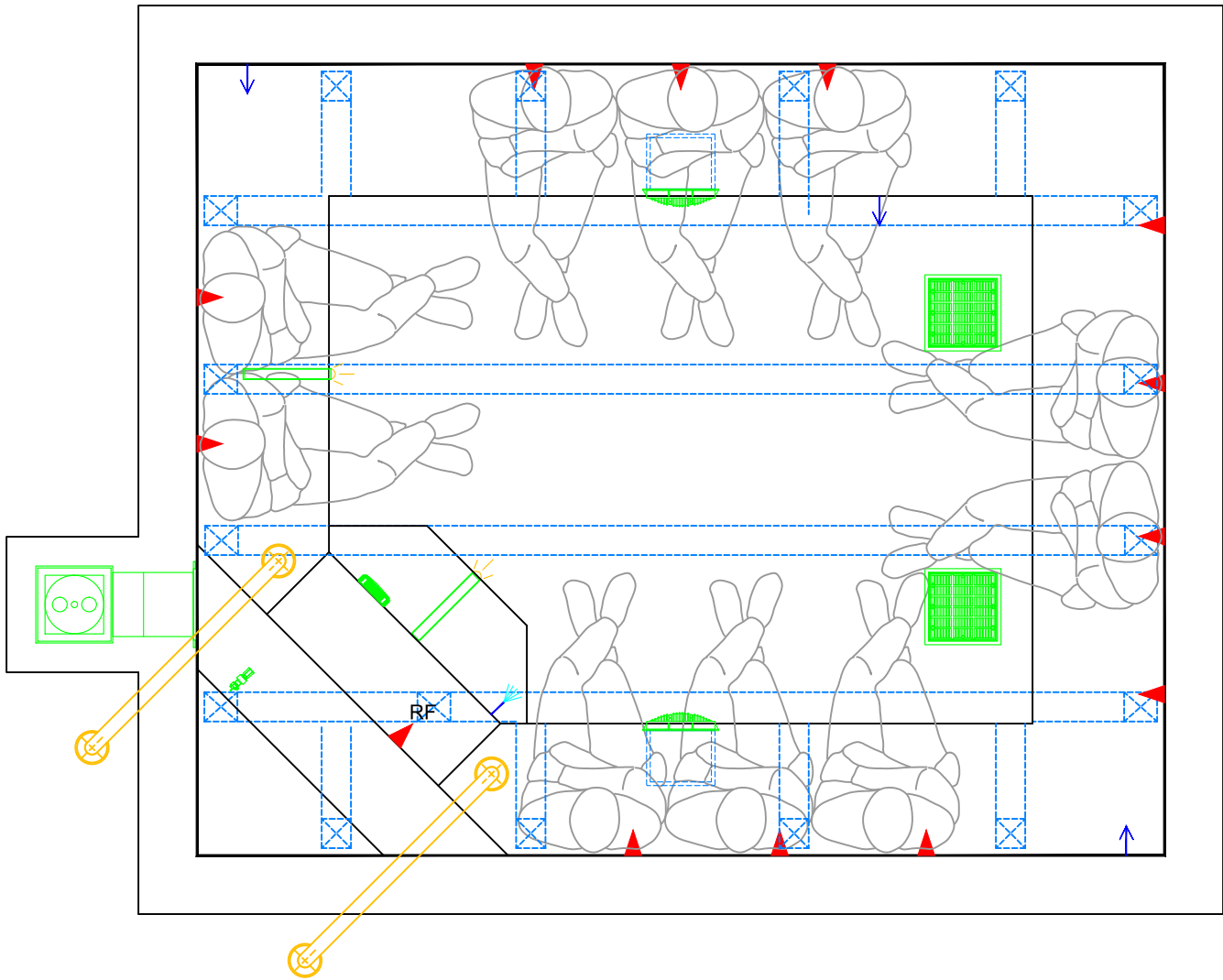

APPROVED

ALL DIMENSIONS SUBJECT TO 1/4" TOLERANCES

All drawing dimensions supplied by **MAINLINE Com Pools INC.** are for reference only. All CAD files were created using AutoCAD file (*.dwg.) and were provided as a service to our customers using AutoCAD. Errors sometimes occur during this process and with software incompatibility upon opening a file. **MAINLINE Com Pools INC.** and/or any authorized distributor of our products will not be held responsible for problems arising from files which have been converted and does not warranty the documents against deficiencies or typographical errors of any kind. We recommend that all measurements are verified with actual physical product before any custom fabrication in the field occurs.







MAINLINE - Commercial Pools, Inc.
 441 Fehely Dr. King of Prussia, PA 19406
 Phone: (610) 279-9285 Fax: (610) 277-4276
 E-Mail: info@mainlinepools.com



SCALE		DWG TYPE
1/2" = 1'		SPA SD (2)
DWG NAME	DATE	SHEET
GOLD TEX	5/24/2012	2 OF 12

These drawings, concepts, and details contained herein are the original proprietary designs of **MAINLINE Com Pools, Inc.**, developed over many years of experience in the industry and as such are protected by the copyright laws of the United States Government. Reproduction of any of the above without written permission to do so by **MAINLINE Com Pools, Inc.** is illegal.

SPECIFICATIONS	
SHELL WEIGHT	14000 LBS.
WATER WEIGHT	41108 LBS.
TOTAL SHELL & WATER WEIGHT	55108.2 LBS.
WATER VOLUME	824 Cu.Ft.
MAX WATER GAL.	6164 GAL.
SURFACE AREA	219.3 SQ. FT.
IAPMO#	1138
FDA#	2030305

SKID SUPPORT STRUCTURE BONDED TO SPA	
	SKIDS SUPPLIED BY MFR.
LIGHT NICHE	
	Neutral 12 V. L.E.D. UL APPROVED
MAIN DRAIN	
	WATERWAY # 604-4700 V 9" X 9" FRAME 30.9 cu. ft. open area + Max Flow 289 GPM @ 2.33 lbs (ft/s) Max Flow 198 GPM @ 1.33 lbs (ft/s) COMPLIES W/ ANSI CODE ASME A112.19.8-07 UL APPROVED
SKIMMER	
	HAUYWARD SP-1084FVE SURFACE SKIMMER W/ EQUALIZER, NSF APPROVED
JET	
	HYDRO INLETS 1/2" WATER = 1/2" AIR HYDROAIR #10-510 COMPLIES W/ ANSI CODE ASME A112.19.8-07 UL APPROVED
RETURN	
	INLET FITTINGS 1/2" WALL TYPE W/ EYEBALL HYDROAIR #10-300 COMPLIES W/ ANSI CODE ASME A112.19.8-07 UL APPROVED
FILL	
	INLET FITTINGS 1/2" WALL TYPE W/ EYEBALL HYDROAIR #10-300 COMPLIES W/ ANSI CODE ASME A112.19.8-07 UL APPROVED

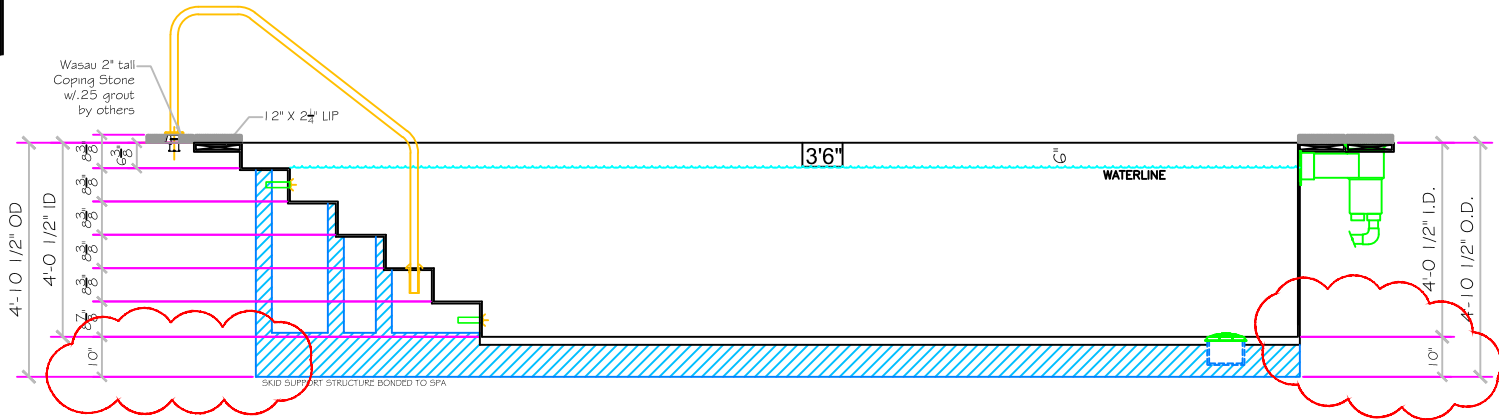
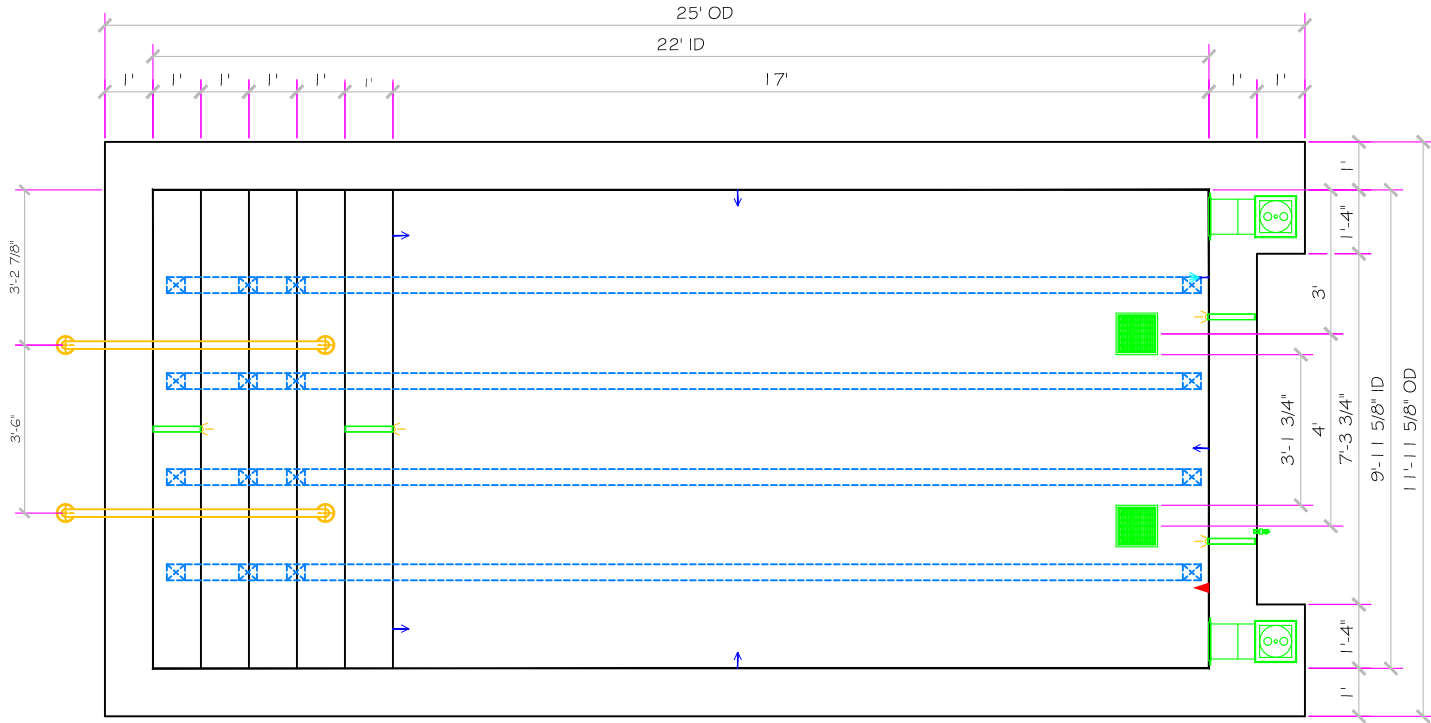

All drawing dimensions supplied by [MAINLINE Com Pools INC.](#) are for reference only. All CAD files were created using AutoCAD file (*.dwg.) and were provided as a service to our customers using AutoCAD. Errors sometimes occur during this process and with software incompatibility upon opening a file. [MAINLINE Com Pools INC.](#) and/or any authorized distributor of our products will not be held responsible for problems arising from files which have been converted and does not warranty the documents against deficiencies or typographical errors of any kind. We recommend that all measurements are verified with actual physical product before any custom fabrication in the field occurs.

APPROVED

ALL DIMENSIONS SUBJECT TO 1/4" TOLERANCES

These drawings, concepts, and details contained herein are the original proprietary designs of **MAINLINE Com Pools, Inc.**, developed over many years of experience in the industry and as such are protected by the copyright laws of the United States Government. Reproduction of any of the above without written permission to do so by **MAINLINE Com Pools, Inc.** is illegal.

MAINLINE - Commercial Pools, Inc.
 441 Fehely Dr. King of Prussia, PA 19406
 Phone: (610) 279-9285 Fax: (610) 277-4276
 E-Mail: info@mainlinepools.com



SCALE		DWG TYPE
1/4" = 1'		Pool SD
DWG NAME	DATE	SHEET
GOLD TEX	8/20/2012	3 OF 12

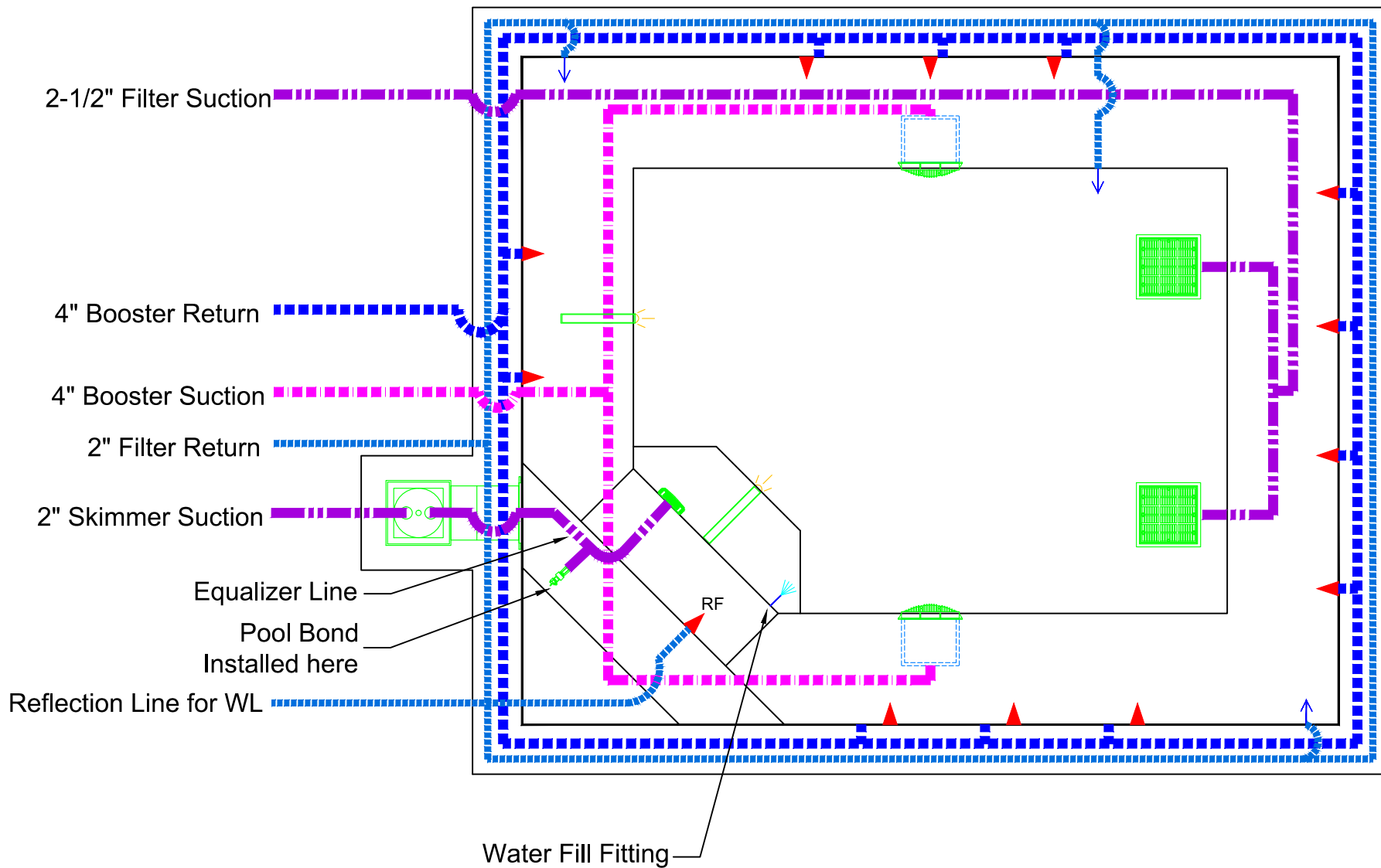

All drawing dimensions supplied by [MAINLINE Com Pools INC.](http://www.mainlinepools.com) are for reference only. All CAD files were created using AutoCAD file (*.dwg.) and were provided as a service to our customers using AutoCAD. Errors sometimes occur during this process and with software incompatibility upon opening a file. [MAINLINE Com Pools INC.](http://www.mainlinepools.com) and/or any authorized distributor of our products will not be held responsible for problems arising from files which have been converted and does not warranty the documents against deficiencies or typographical errors of any kind. We recommend that all measurements are verified with actual physical product before any custom fabrication in the field occurs.

APPROVED

ALL DIMENSIONS SUBJECT TO 1/4" TOLERANCES

These drawings, concepts, and details contained herein are the original proprietary designs of **MAINLINE Com Pools, Inc.**, developed over many years of experience in the industry and as such are protected by the copyright laws of the United States Government. Reproduction of any of the above without written permission to do so by **MAINLINE Com Pools, Inc.** is illegal.

MAINLINE - Commercial Pools, Inc.
 441 Fehely Dr. King of Prussia, PA 19406
 Phone: (610) 279-9285 Fax: (610) 277-4276
 E-Mail: info@mainlinepools.com



SCALE	DWG TYPE	
1/2" = 1'	Spa Plumbing	
DWG NAME	DATE	SHEET
GOLD TEX	5/24/2012	4 OF 12

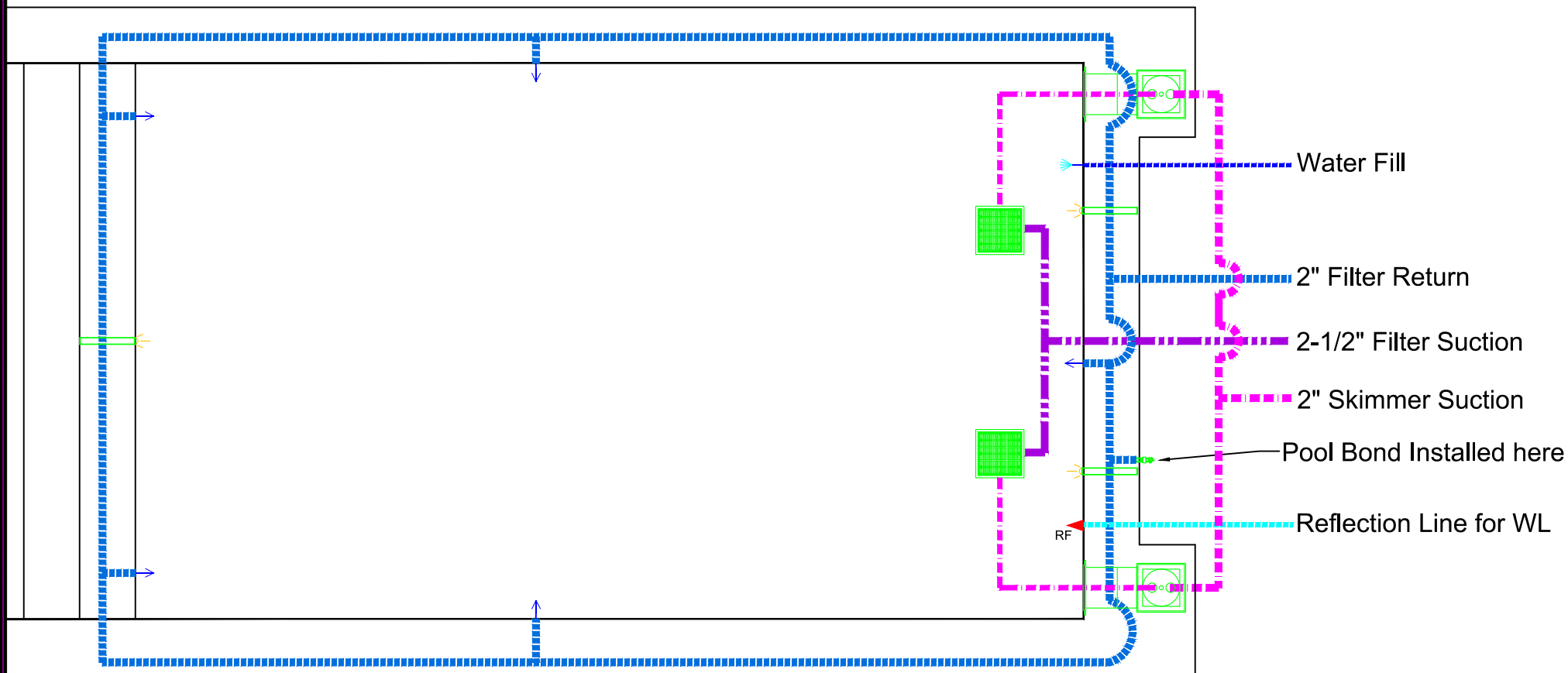

All drawing dimensions supplied by [MAINLINE Com Pools INC.](http://www.mainlinepools.com) are for reference only. All CAD files were created using AutoCAD file (*.dwg.) and were provided as a service to our customers using AutoCAD. Errors sometimes occur during this process and with software incompatibility upon opening a file. [MAINLINE Com Pools INC.](http://www.mainlinepools.com) and/or any authorized distributor of our products will not be held responsible for problems arising from files which have been converted and does not warranty the documents against deficiencies or typographical errors of any kind. We recommend that all measurements are verified with actual physical product before any custom fabrication in the field occurs.

APPROVED

ALL DIMENSIONS SUBJECT TO 1/4" TOLERANCES

These drawings, concepts, and details contained herein are the original proprietary designs of **MAINLINE Com Pools, Inc.**, developed over many years of experience in the industry and as such are protected by the copyright laws of the United States Government. Reproduction of any of the above without written permission to do so by **MAINLINE Com Pools, Inc.** is illegal.

MAINLINE - Commercial Pools, Inc.

441 Fehely Dr. King of Prussia, PA 19406

Phone: (610) 279-9285

Fax: (610) 277-4276

E-Mail: info@mainlinepools.com



SCALE
3/8" = 1'

DWG TYPE
Pool Plumbing

DWG NAME
GOLD TEX

DATE
6/15/2012

SHEET
5 OF 12

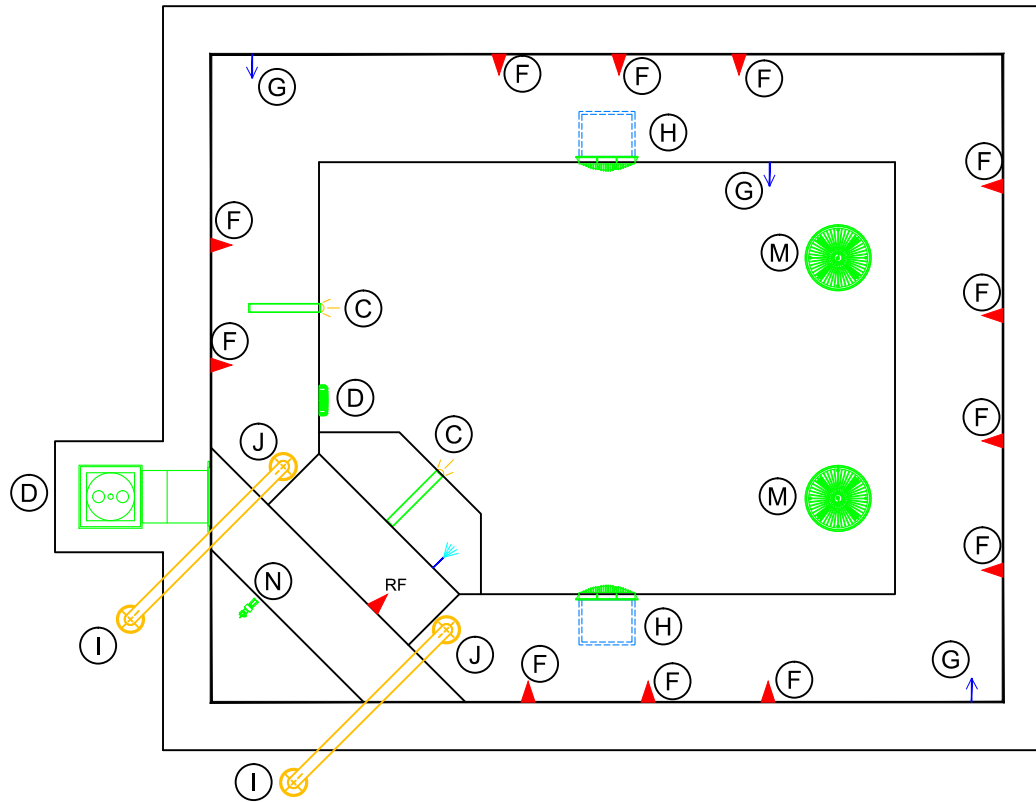

ITEM	DESCRIPTION	MANUFACTURER	CATALOG NO.	QTY.
C	NEXXUS, WHITE, 12 V, L.E.D., U.L. APPROVED	NEXXUS	12 V	2
D	SURFACE SKIMMER W/ EQUALIZER, NSF APPROVED	HAYWARD	SP-1084 FVE	1
F	HYDRO INLETS, 1 1/2" WATER, 1 1/2" AIR	HYDROAIR	10-5100	12
G	INLET FITTINGS, 1 1/2", WALL TYPE, W/ EYEBALL	HYDROAIR	10-3500	3
H	WATERWAY # 640-4700 V 9" X 9" FRAME, 39.9 sq. in. open area- Max Flow 289 GPM @ 2.33 fps (floor) Max Flow 198 GPM @ 1.59 fps (wall) COMPLIES W/ ANSI CODE ASME A112.19.8-07 UL APPROVED	WATERWAY	# 640-4700 V	2
I	HAND RAIL, STAINLESS STEEL, 3' 0" LENGTH, W/ .065TUBING WALL THICKNESS	S.R. SMITH	DMS-101	2
J	BRONZE COMPRESSION CUP ANCHOR (6" X 1-1/2")	STANDARD BRONZE	PART # 5794	2
M	WATERWAY # 640-1900 V 10" Rnd open area - 30.9 sq. in. Max Flow 143 GPM @ 6.0 fps (floor) COMPLIES W/ ANSI CODE ASME A112.19.8-07 UL APPROVED	WATERWAY	# 640-1900 V	2
N	POOL BOND PB-2008 Complies w/ National Electrical Code 680.26 (C)	Perma-Cast	PB-2008	1

APPROVED

ALL DIMENSIONS SUBJECT TO 1/4" TOLERANCES

These drawings, concepts, and details contained herein are the original proprietary designs of **MAINLINE Com Pools, Inc.**, developed over many years of experience in the industry and as such are protected by the copyright laws of the United States Government. Reproduction of any of the above without written permission to do so by **MAINLINE Com Pools, Inc.** is illegal.

MAINLINE - Commercial Pools, Inc.
 441 Fehelley Dr. King of Prussia, PA 19406
 Phone: (610) 279-9285 Fax: (610) 277-4276
 E-Mail: info@mainlinepools.com



SCALE 3/8" = 1'	DWG TYPE Spa Equipment
DWG NAME GOLD TEX	DATE 5/24/2012
SHEET 6 OF 12	

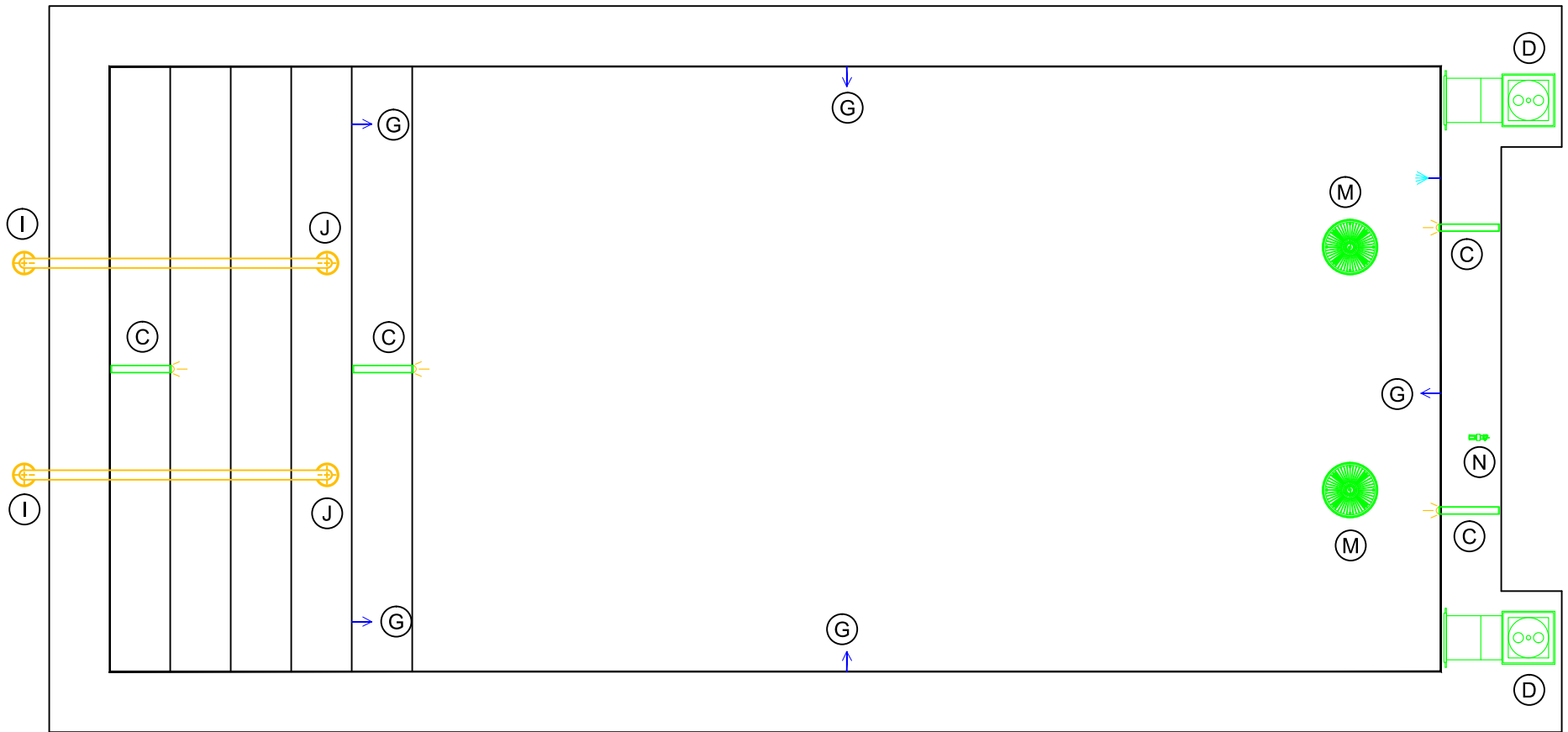

ITEM	DESCRIPTION	MANUFACTURER	CATALOG NO.	QTY.
C	NEXXUS, WHITE, 12 V, L.E.D., U.L. APPROVED	NEXXUS	12 V	4
D	SURFACE SKIMMER W/ EQUALIZER, NSF APPROVED	HAYWARD	SP-1084 FVE	2
G	INLET FITTINGS, 1 1/2", WALL TYPE, W/ EYEBALL	HYDROAIR	10-3500	5
I	HAND RAIL, STAINLESS STEEL, 5' 0" LENGTH, W/ .065 TUBING WALL THICKNESS	S.R. SMITH	DMS-101	2
J	BRONZE COMPRESSION CUP ANCHOR (6" X 1-1/2")	STANDARD BRONZE	PART # 5794	2
M	WATERWAY # 640-1900 V 10" Rnd open area - 30.9 sq. in. Max Flow 143 GPM @ 6.0 fps (floor) COMPLIES W/ ANSI CODE ASME A112.19.8-07 UL APPROVED	WATERWAY	# 640-1900 V	2
N	POOL BOND PB-2008 Complies w/ National Electrical Code 680.26 (C)	Perma-Cast	PB-2008	1

APPROVED

ALL DIMENSIONS SUBJECT TO 1/4" TOLERANCES

These drawings, concepts, and details contained herein are the original proprietary designs of **MAINLINE Com Pools, Inc.**, developed over many years of experience in the industry and as such are protected by the copyright laws of the United States Government. Reproduction of any of the above without written permission to do so by **MAINLINE Com Pools, Inc.** is illegal.

MAINLINE - Commercial Pools, Inc.
 441 Fehelley Dr. King of Prussia, PA 19406
 Phone: (610) 279-9285 Fax: (610) 277-4276
 E-Mail: info@mainlinepools.com



SCALE	DWG TYPE	
3/8" = 1'	Pool Equipment	
DWG NAME	DATE	SHEET
GOLD TEX	6/15/2012	7 OF 12

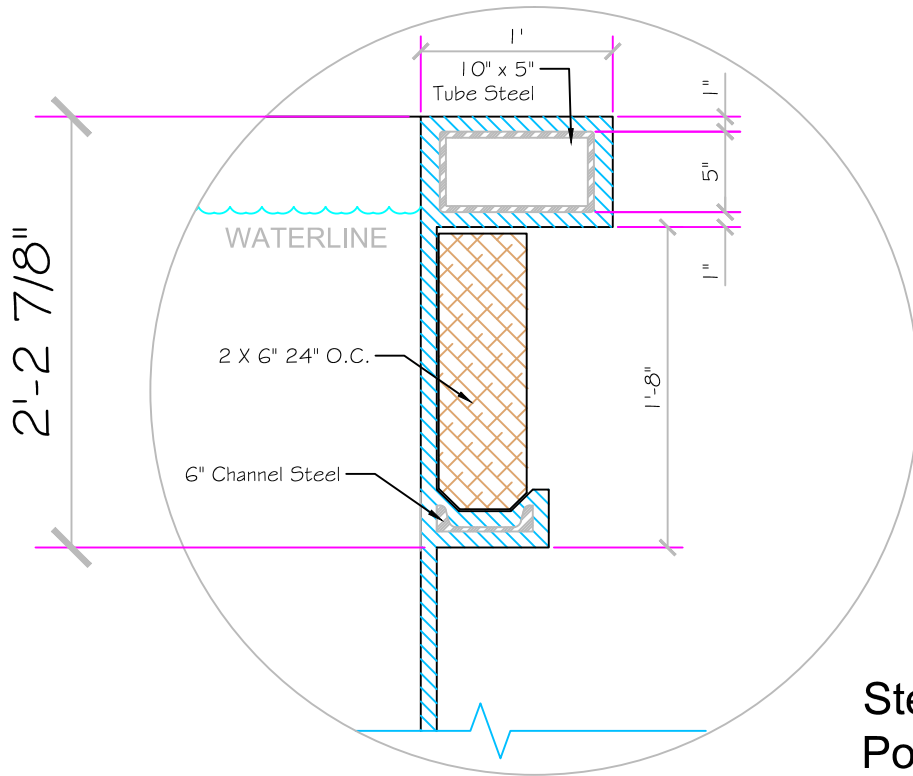

Steel Detail
Pool Sides

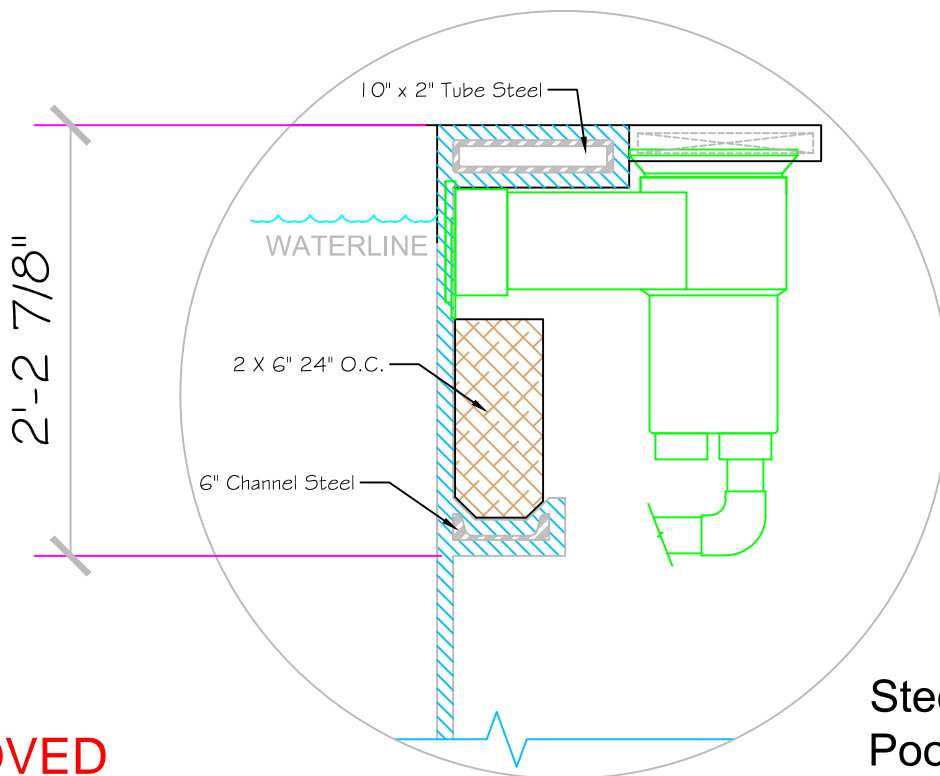

Steel Detail
Pool Skimmer End

APPROVED

ALL DIMENSIONS SUBJECT TO 1/4" TOLERANCES

All drawing dimensions supplied by **MAINLINE Com Pools INC.** are for reference only. All CAD files were created using AutoCAD file (*.dwg.) and were provided as a service to our customers using AutoCAD. Errors sometimes occur during this process and with software incompatibility upon opening a file. **MAINLINE Com Pools INC.** and/or any authorized distributor of our products will not be held responsible for problems arising from files which have been converted and does not warranty the documents against deficiencies or typographical errors of any kind. We recommend that all measurements are verified with actual physical product before any custom fabrication in the field occurs.

MAINLINE - Commercial Pools, Inc.
 441 Fehely Dr. King of Prussia, PA 19406
 Phone: (610) 279-9285 Fax: (610) 277-4276
 E-Mail: info@mainlinepools.com



SCALE 1" = 1'	DWG TYPE Pool Steel Detail	
DWG NAME GOLD TEX	DATE 5/22/2012	SHEET 8 OF 12

These drawings, concepts, and details contained herein are the original proprietary designs of **MAINLINE Com Pools, Inc.**, developed over many years of experience in the industry and as such are protected by the copyright laws of the United States Government. Reproduction of any of the above without written permission to do so by **MAINLINE Com Pools, Inc.** is illegal.

17'

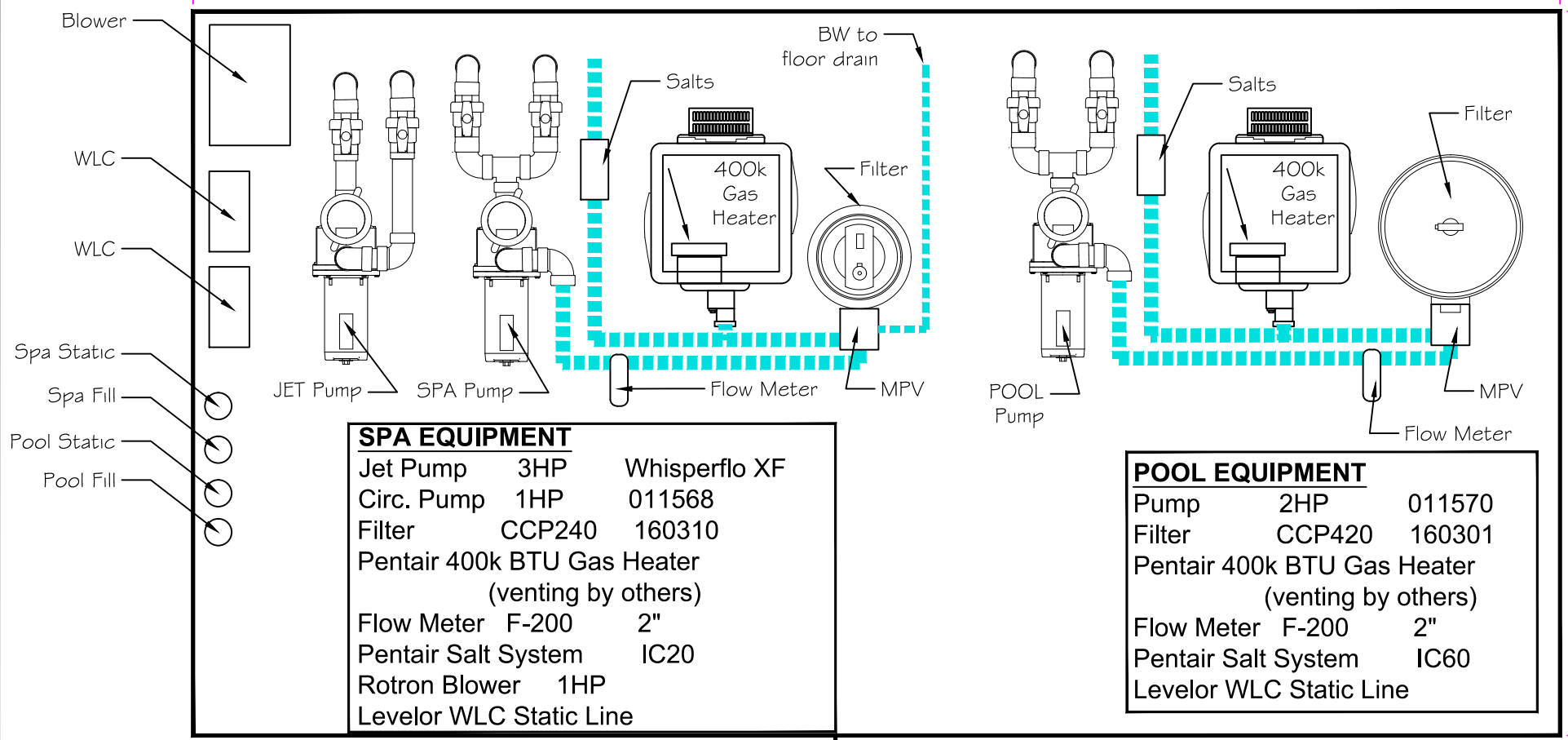

SPA EQUIPMENT		
Jet Pump	3HP	Whisperflo XF
Circ. Pump	1HP	011568
Filter	CCP240	160310
Pentair 400k BTU Gas Heater (venting by others)		
Flow Meter	F-200	2"
Pentair Salt System IC20		
Rotron Blower 1HP		
Levelor WLC Static Line		

POOL EQUIPMENT		
Pump	2HP	011570
Filter	CCP420	160301
Pentair 400k BTU Gas Heater (venting by others)		
Flow Meter	F-200	2"
Pentair Salt System IC60		
Levelor WLC Static Line		

Spa Gallons Pump- Pentair – 1hp.
 Turnover Rate 1570 gallons 73 GPM 22 minutes

Spa Cartridge Filter CCP240 240 sq.ft. x .375
 Filter Max Flow Rate 90 GPM Spa Filter Rate 73 GPM

Pool Gallons Filter Pump Pentair– 2hp.
 Turnover Rate 6164 gallons 114 GPM 54 minutes

Pool Cartridge Filter CCP420 420 sq.ft. x .375
 Filter Max. Flow Rate 157 GPM Pool Filter Rate 114 GPM

APPROVED

ALL DIMENSIONS SUBJECT TO 1/4" TOLERANCES

These drawings, concepts, and details contained herein are the original proprietary designs of **MAINLINE Com Pools, Inc.**, developed over many years of experience in the industry and as such are protected by the copyright laws of the United States Government. Reproduction of any of the above without written permission to do so by **MAINLINE Com Pools, Inc.**, is illegal.

MAINLINE - Commercial Pools, Inc.
 441 Fehelley Dr. King of Prussia, PA 19406
 Phone: (610) 279-9285 Fax: (610) 277-4276
 E-Mail: info@mainlinepools.com



SCALE	DWG TYPE	
N/A	Equipment Layout	
DWG NAME	DATE	SHEET
GOLD TEX	5/22/2012	9 OF 12

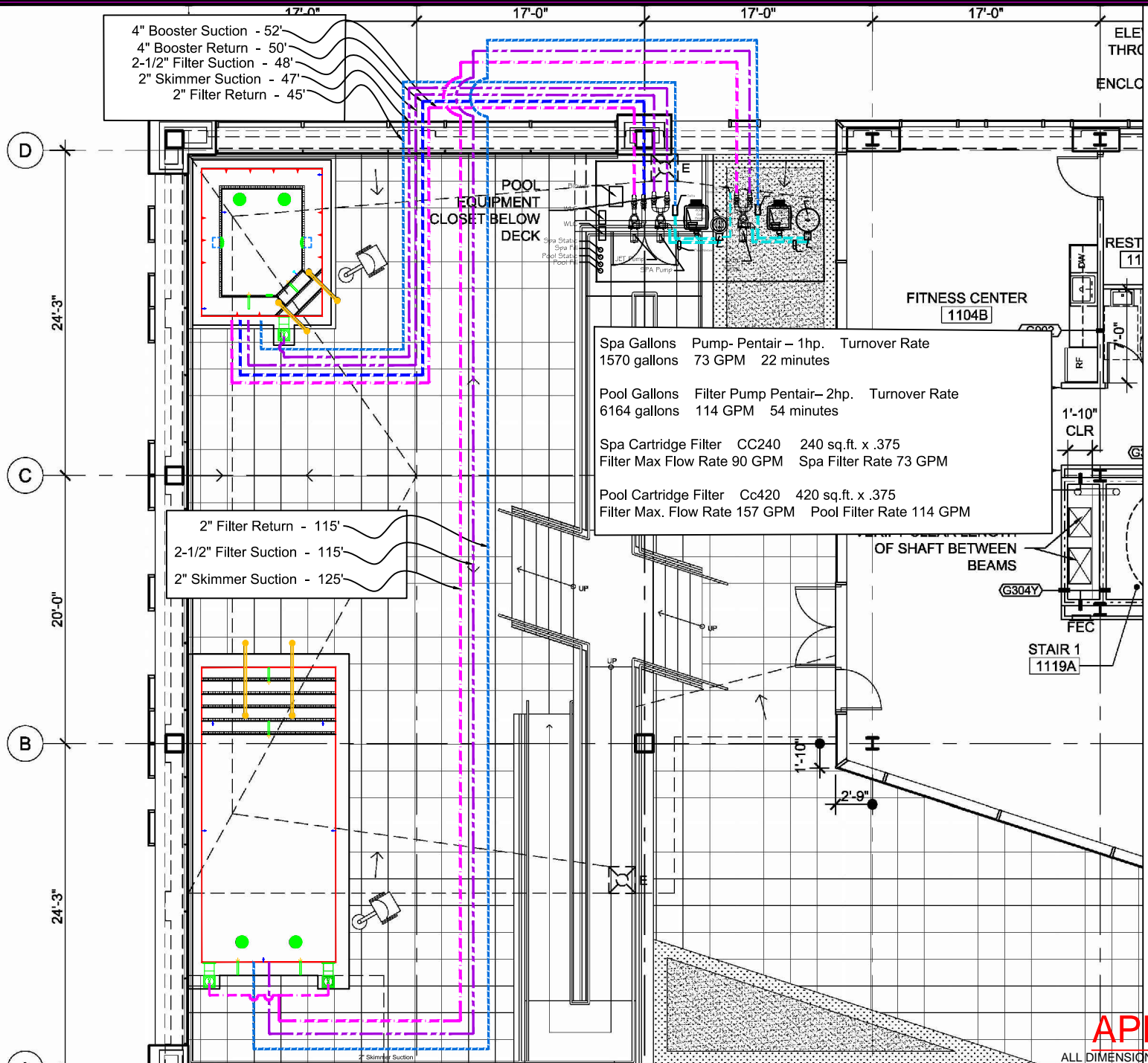

APPROVED

ALL DIMENSIONS SUBJECT TO 1/4" TOLERANCES

These drawings, concepts, and details contained herein are the original proprietary designs of **MAINLINE Com Pools, Inc.**, developed over many years of experience in the industry and as such are protected by the copyright laws of the United States Government. Reproduction of any of the above without written permission to do so by **MAINLINE Com Pools, Inc.**, is illegal.

MAINLINE - Commercial Pools, Inc.
 441 Fehelley Dr. King of Prussia, PA 19406
 Phone: (610) 279-9285 Fax: (610) 277-4276
 E-Mail: info@mainlinepools.com



SCALE	DWG TYPE	
3/32" = 1'	Spa & Pool Layout	
DWG NAME	DATE	SHEET
GOLD TEX	6/15/2012	10 OF 12

POOL BONDING REQUIREMENTS:

1. THE FOLLOWING PARTS SHALL BE BONDED TOGETHER AND CONNECTED TO THE COMMON BONDING GRID.
 - A. ALL THE METALLIC PARTS OF THE POOL STRUCTURE INCLUDING COPING STONES, DECK, PERMANENT PLAY STRUCTURES, PERMANENT EXERCISE STRUCTURES.
 - B. ALL METAL FITTINGS WITHIN OR ATTACHED TO THE POOL STRUCTURE
 - C. METAL PARTS ASSOCIATED WITH THE POOL WATER CIRCULATING SYSTEM, INCLUDING PUMPS, FILTERS, AND HEATERS.
 - D. METAL PARTS ASSOCIATED WITH POOL COVERS
 - E. METAL SHEATHED CABLES AND RACEWAYS, METAL PIPING AND ALL FIXED METAL PARTS WITHIN 5 FEET HORIZONTALLY OF INSIDE WALLS OF POOL AND WITHIN 12 FEET ABOVE MAXIMUM WATER LEVEL OF POOL.
 - F. METAL PARTS ASSOCIATED WITH OBSERVATION STANDS, TOWERS, PLATFORMS, AND DIVING STRUCTURES.
2. BONDING CONDUCTORS SHALL BE MINIMUM #8 SOLID COPPER, INSULATED E.C. SHALL COORDINATE APPROVED CONNECTOR TYPE AND METHOD WITH LOCAL ELECTRICAL AND/ OR POOL INSPECTOR.
3. SPECIFIC MANUFACTURER'S INSTRUCTIONS REGARDING BONDING OR GROUNDING OF POOL EQUIPMENT, WHETHER INDICATED HEREIN OR NOT, SHALL BE STRICTLY FOLLOWED.
4. THE COMMON BONDING GRID SHALL NOT BE CONNECTED TO ANY ELECTRICAL DISTRIBUTION EQUIPMENT.
5. ANY PARTS IN ADDITION TO THOSE DESCRIBED HEREIN THAT ARE INDICATED BY POOL CONTRACTOR OR LOCAL INSPECTION AUTHORITY SHALL BE BONDED TO THE COMMON BONDING GRID WITH NO ADDITIONAL COSTS INCURRED BY THE OWNER.
6. THE ELECTRICAL CONTRACTOR SHALL COORDINATE BONDING WITH GENERAL CONTRACTOR.

LIGHT DETAIL

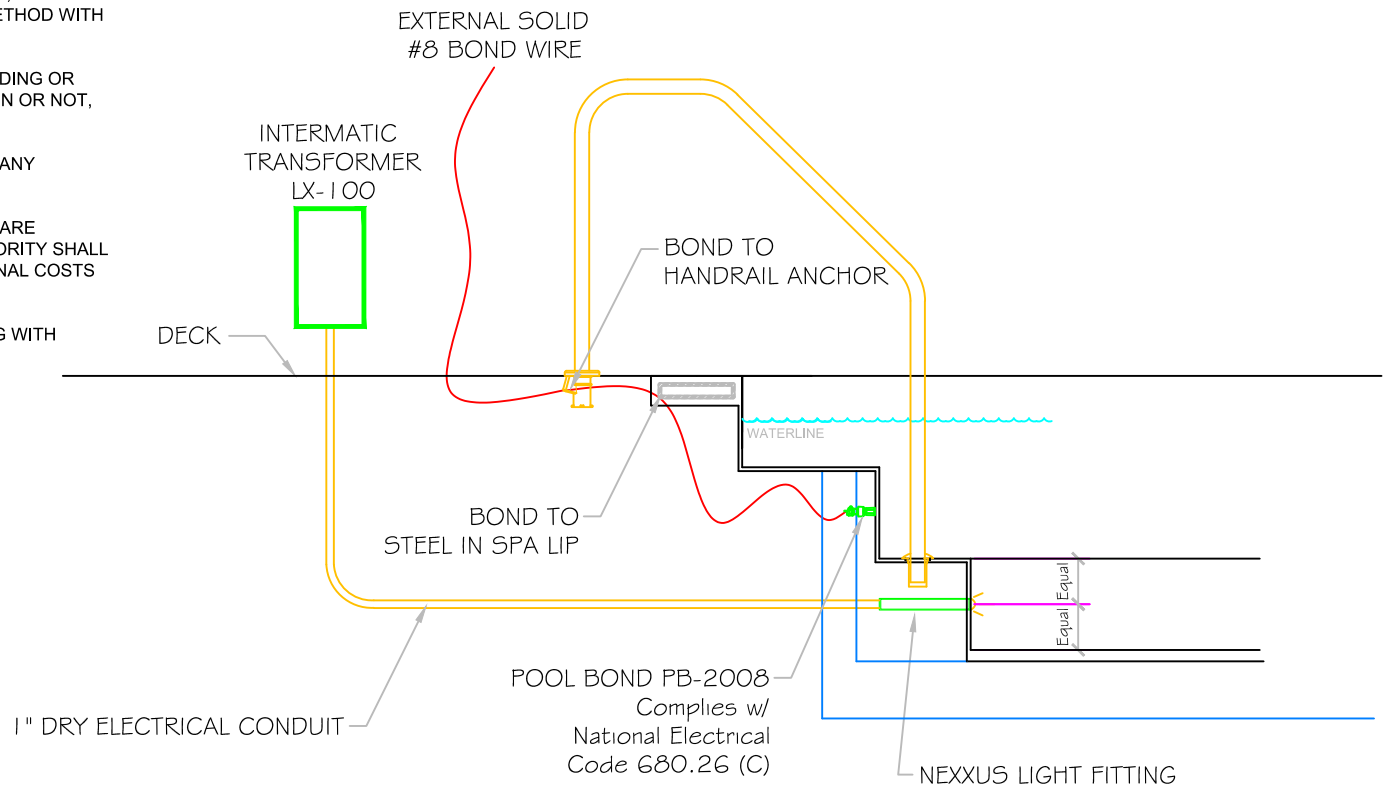

APPROVED

ALL DIMENSIONS SUBJECT TO 1/4" TOLERANCES

These drawings, concepts, and details contained herein are the original proprietary designs of **MAINLINE Com Pools, Inc.**, developed over many years of experience in the industry and as such are protected by the copyright laws of the United States Government. Reproduction of any of the above without written permission to do so by **MAINLINE Com Pools, Inc.** is illegal.

MAINLINE - Commercial Pools, Inc.

441 Fehelley Dr. King of Prussia, PA 19406

Phone: (610) 279-9285

Fax: (610) 277-4276

E-Mail: info@mainlinepools.com



SCALE	N/A		DWG TYPE
			Bonding Detail
DWG NAME	DATE	SHEET	
GOLD TEX	5/22/2012	11 OF 12	

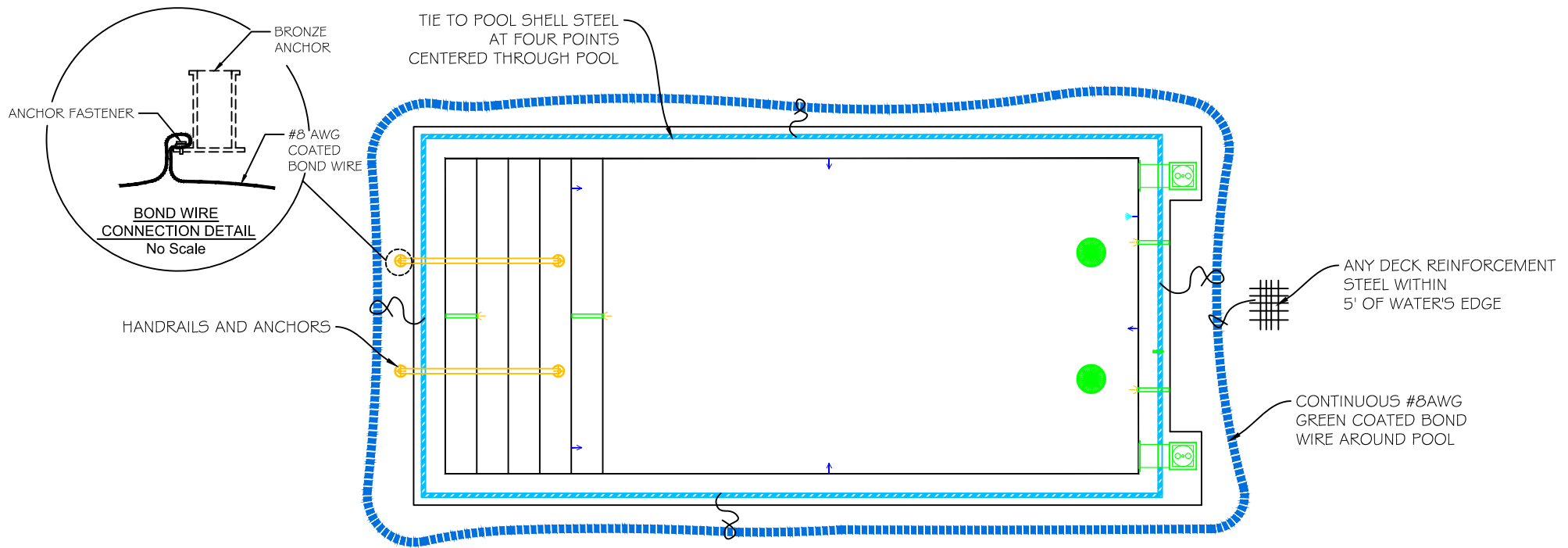

TYPICAL BONDING DETAIL

1. INSTALL PER NEC 2008, SECTION 680 REQUIREMENTS
2. USE #8 COATED TAILS OFF BOND LOOP TO EQUIPMENT AND STEEL NOT IMMEDIATELY ADJACENT TO BOND LOOP

APPROVED

ALL DIMENSIONS SUBJECT TO 1/4" TOLERANCES

These drawings, concepts, and details contained herein are the original proprietary designs of **MAINLINE Com Pools, Inc.**, developed over many years of experience in the industry and as such are protected by the copyright laws of the United States Government. Reproduction of any of the above without written permission to do so by **MAINLINE Com Pools, Inc.** is illegal.

MAINLINE - Commercial Pools, Inc.

441 Fehelley Dr. King of Prussia, PA 19406

Phone: (610) 279-9285 Fax: (610) 277-4276

E-Mail: info@mainlinepools.com



SCALE N/A	DWG TYPE Bonding Detail (2)	
DWG NAME GOLD TEX	DATE 6/15/2012	SHEET 12 OF 12



Pavers Installations/Specifications

Installations/Specifications

There are so many uses for concrete pavers. Choose an installation that best meets your requirements for use and desired look of the finished project. Your Wausau Tile representative can assist you in determining which installation best suits your needs, or answer any other questions you may have. Each installation listed shows a pedestrian or vehicular method.

Property	Value	Test Method
Compressive Strength	=>8,000 psi ave	ASTM C140
Flexural Strength	=>800 psi ave	ASTM C293
Water Absorption	<6%	ASTM C140
Freeze/Thaw	=<1% loss of dry weight (50 cycles)	ASTM C67
Center Load	1,850 lbs	WTCL 99

Installation Types

- Mortar-Set Installation
- Sand-Set Installation
- Bituminous Installation
- Terra-System One Sloped Installation Method
- Terra-System One Level Installation Method
- Pedestal/ Roof Deck System Components

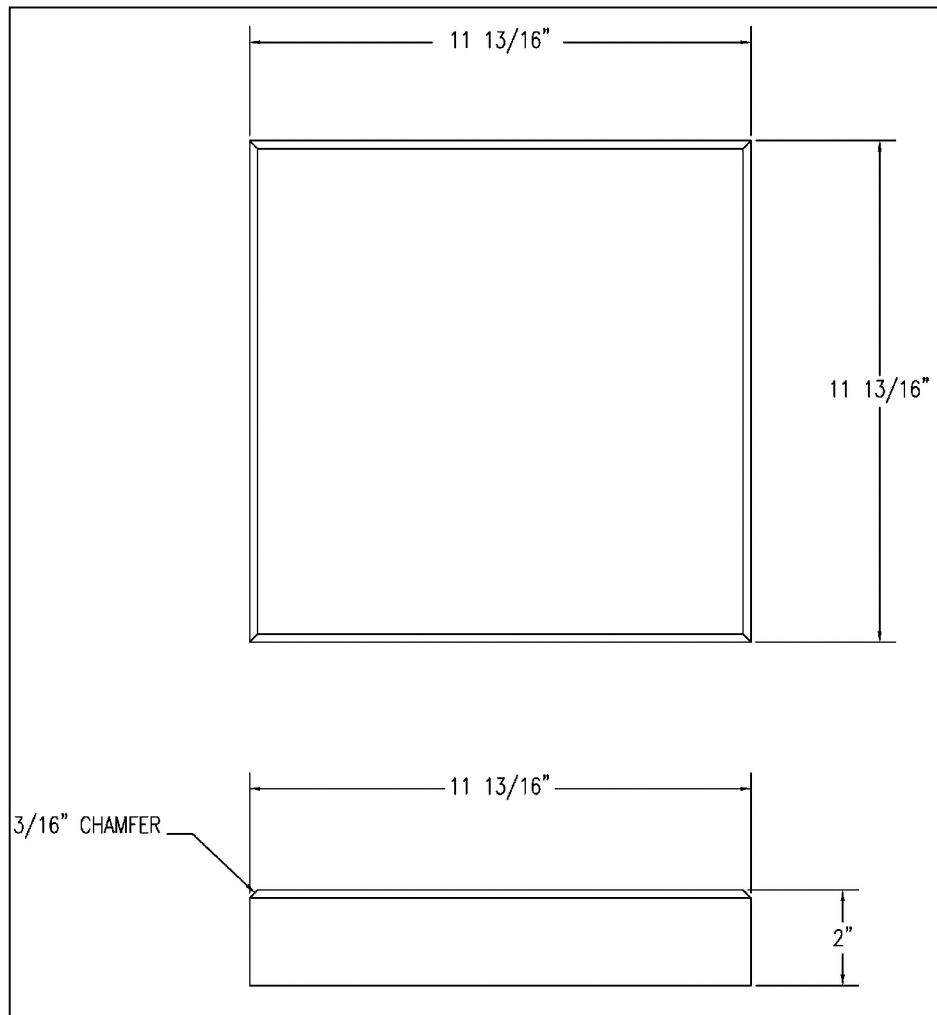

APPROVED

ALL DIMENSIONS SUBJECT TO 1/4" TOLERANCES

MAINLINE - Commercial Pools, Inc.
 441 Fehely Dr. King of Prussia, PA 19406
 Phone: (610) 279-9285 Fax: (610) 277-4276
 E-Mail: info@mainlinepools.com



SCALE N/A	DWG TYPE Coping Detail	
DWG NAME GOLD TEX	DATE 5/22/2012	SHEET 1 OF 1

Walls and Steps
AG100 White
316 Sq Ft

Trim
AG803 Dark Blue
5 Sq Ft

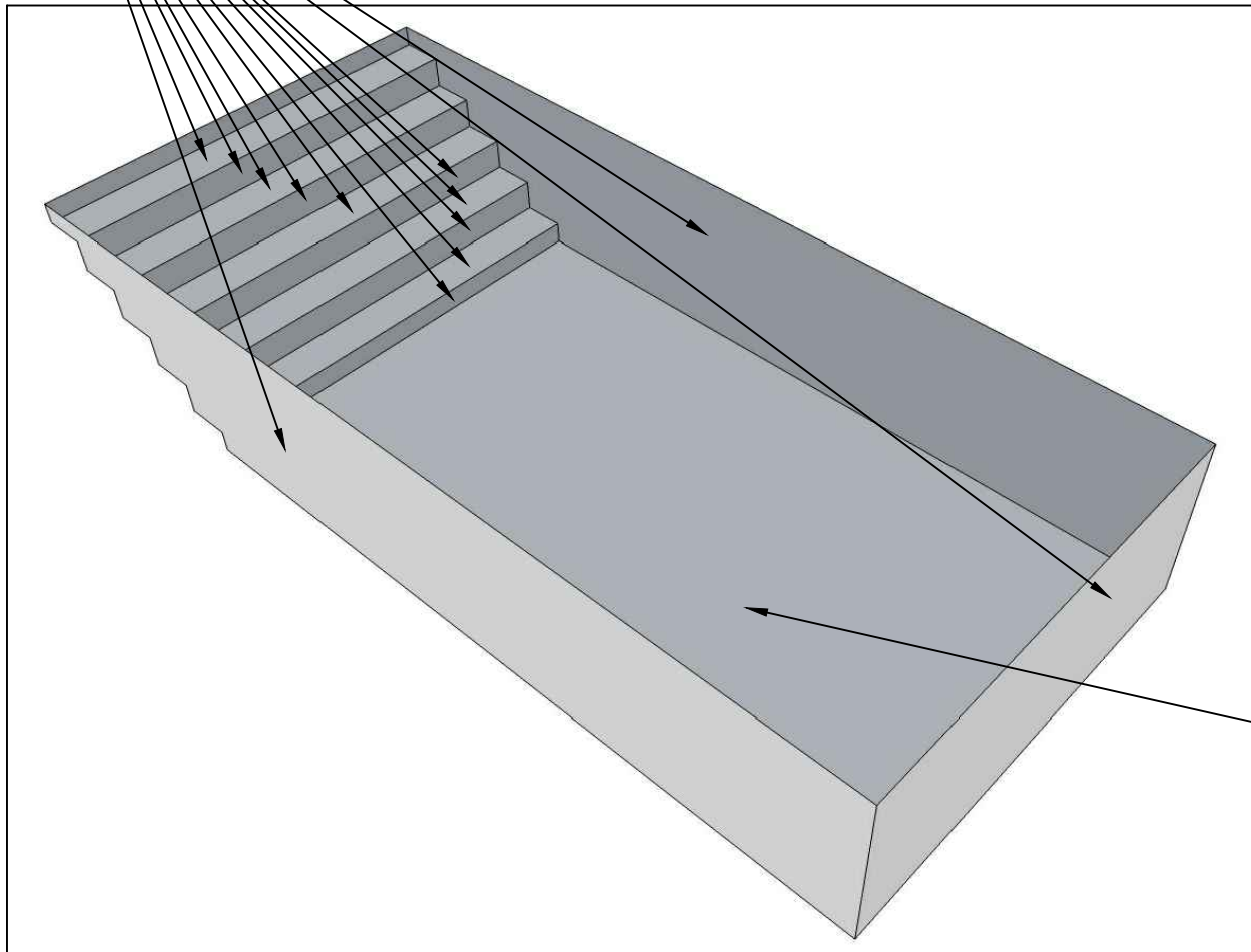

Floor
Gradient Blend
187 Sq Ft

APPROVED

ALL DIMENSIONS SUBJECT TO 1/4" TOLERANCES

These drawings, concepts, and details contained herein are the original proprietary designs of **MAINLINE Com Pools, Inc.**, developed over many years of experience in the industry and as such are protected by the copyright laws of the United States Government. Reproduction of any of the above without written permission to do so by **MAINLINE Com Pools, Inc.** is illegal.

MAINLINE - Commercial Pools, Inc.
441 Fehely Dr. King of Prussia, PA 19406
Phone: (610) 279-9285 Fax: (610) 277-4276
E-Mail: info@mainlinepools.com



SCALE N/A	DWG TYPE Pool Tile Calc	
DWG NAME GOLD TEX	DATE 6/12/2012	SHEET 1 OF 2

Walls and Steps
AG100 White
113 Sq Ft

Trim
AG803 Dark Blue
4 Sq Ft

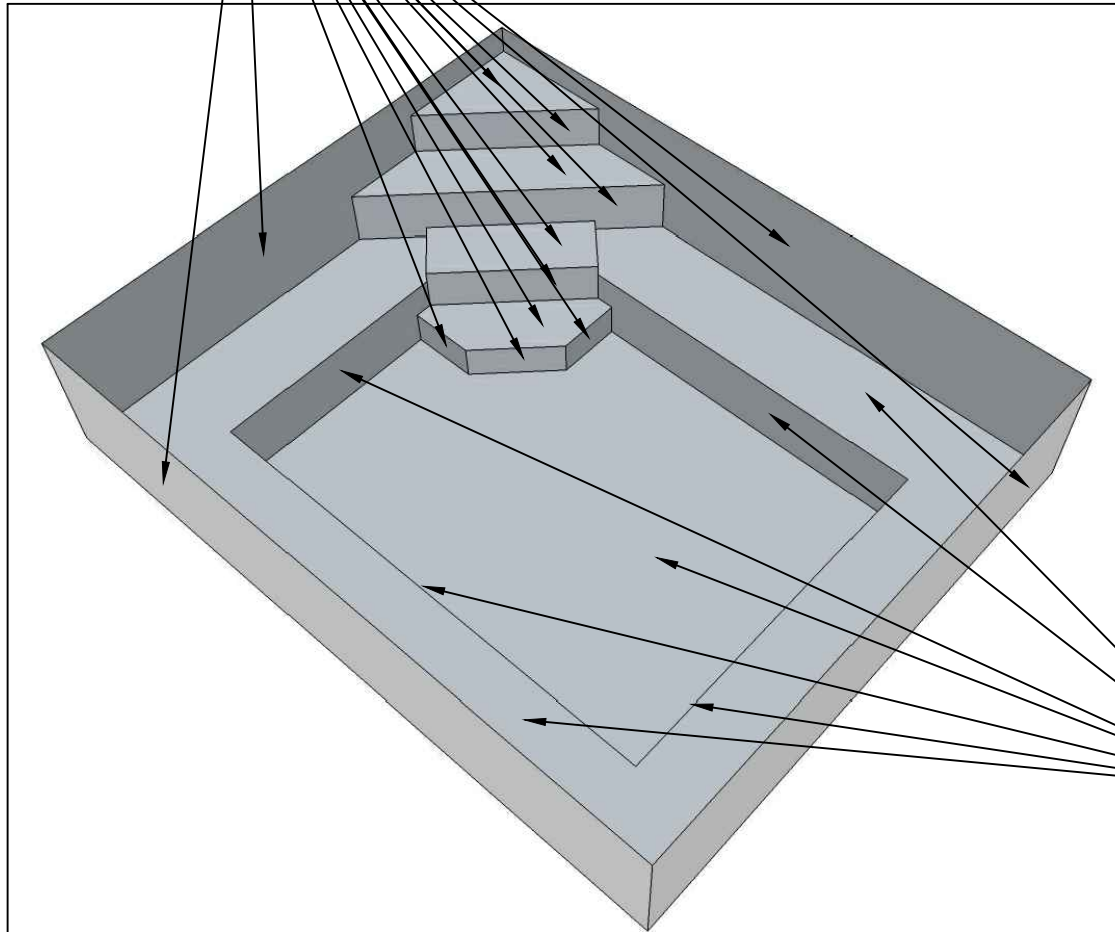

Floor Footwell and Ledge
Mosaic Blend
128 Sq Ft

APPROVED

ALL DIMENSIONS SUBJECT TO 1/4" TOLERANCES

These drawings, concepts, and details contained herein are the original proprietary designs of **MAINLINE Com Pools, Inc.**, developed over many years of experience in the industry and as such are protected by the copyright laws of the United States Government. Reproduction of any of the above without written permission to do so by **MAINLINE Com Pools, Inc.** is illegal.

MAINLINE - Commercial Pools, Inc.
441 Fehely Dr. King of Prussia, PA 19406
Phone: (610) 279-9285 Fax: (610) 277-4276
E-Mail: info@mainlinepools.com



SCALE N/A	DWG TYPE Spa Tile Calc (2)	
DWG NAME GOLD TEX	DATE 6/12/2012	SHEET 2 OF 2

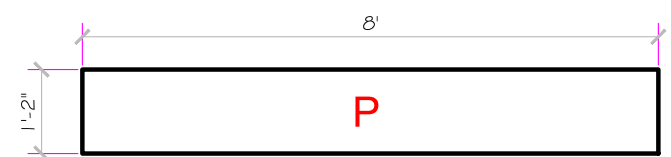
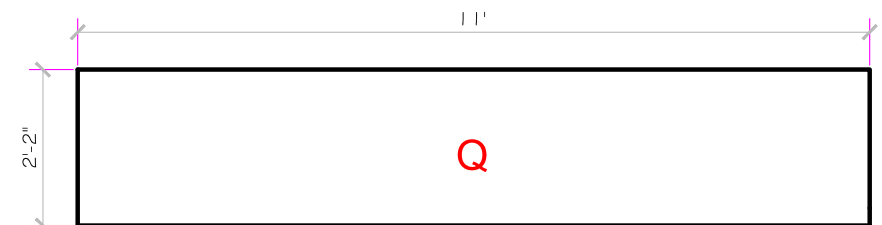
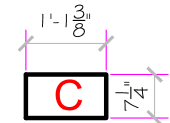
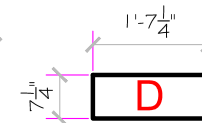
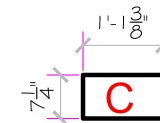
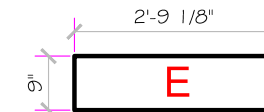
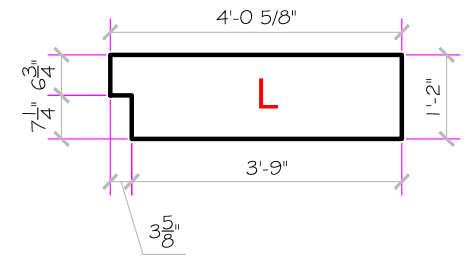
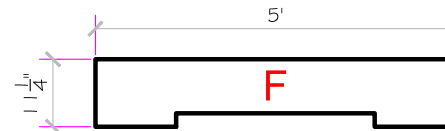
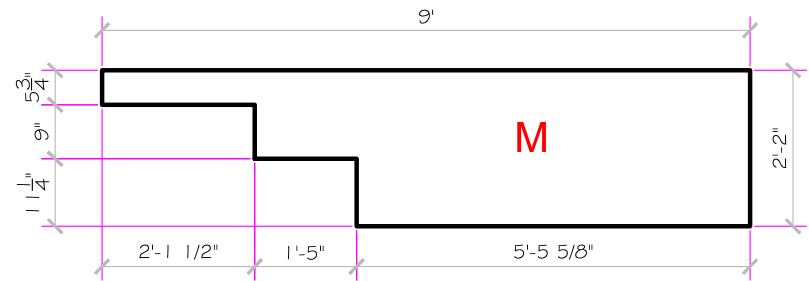
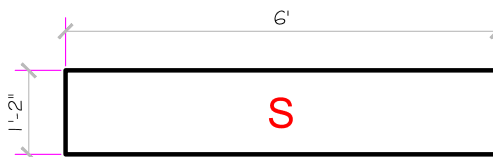
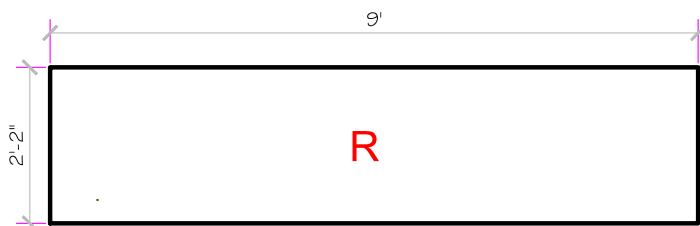
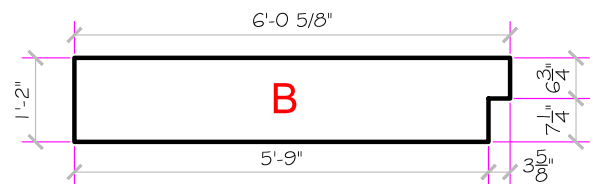
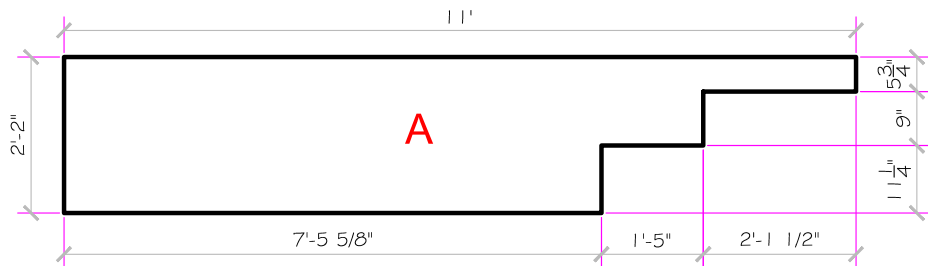
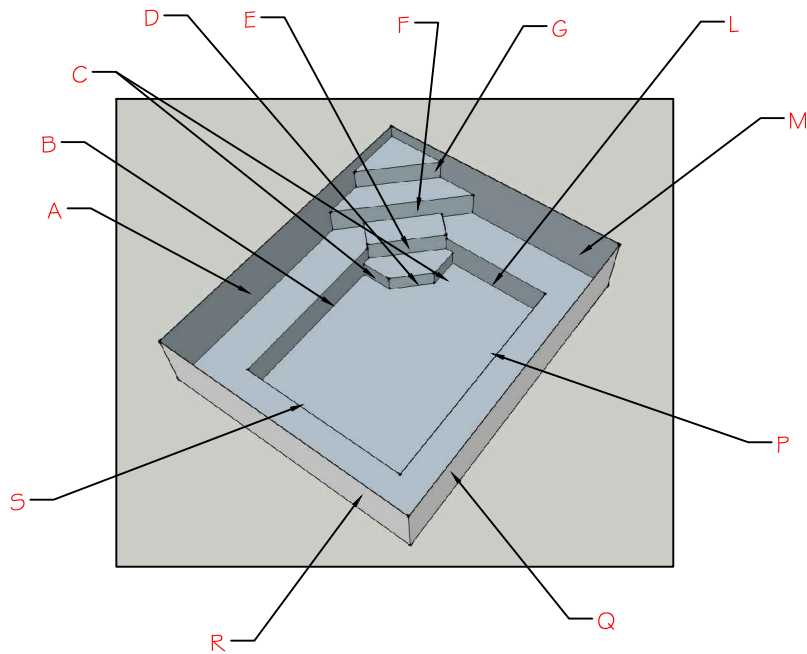

ALL DIMENSIONS SUBJECT TO 1/4" TOLERANCES

These drawings, concepts, and details contained herein are the original proprietary designs of **MAINLINE Com Pools, Inc.**, developed over many years of experience in the industry and as such are protected by the copyright laws of the United States Government. Reproduction of any of the above without written permission to do so by **MAINLINE Com Pools, Inc.** is illegal.

MAINLINE - Commercial Pools, Inc.
 441 Fehely Dr. King of Prussia, PA 19406
 Phone: (610) 279-9285 Fax: (610) 277-4276
 E-Mail: info@mainlinepools.com



SCALE 3/8" = 1'	DWG TYPE Spa Table Set	
DWG NAME GOLD TEX	DATE 6/18/2012	SHEET 1 OF 1

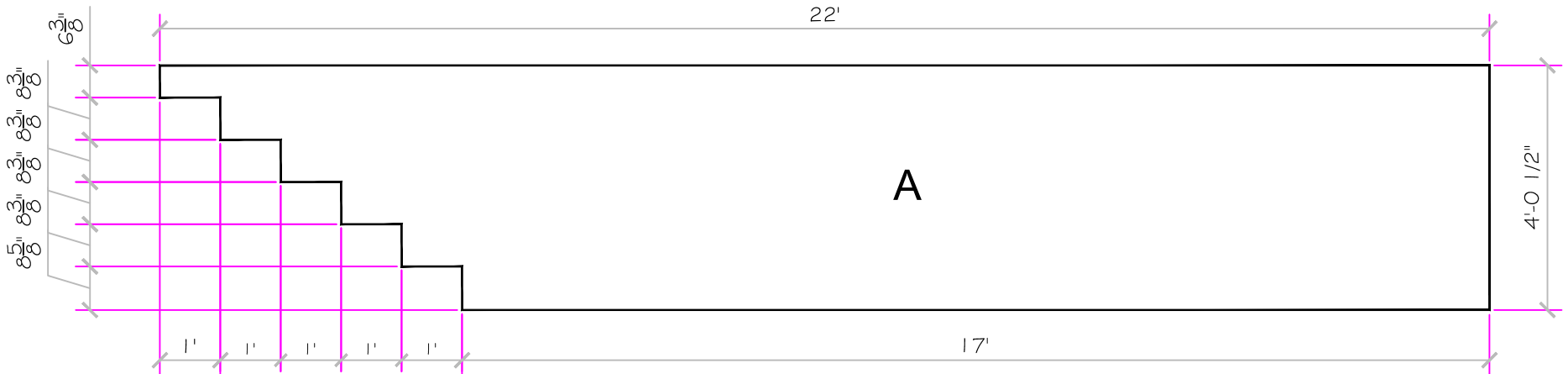
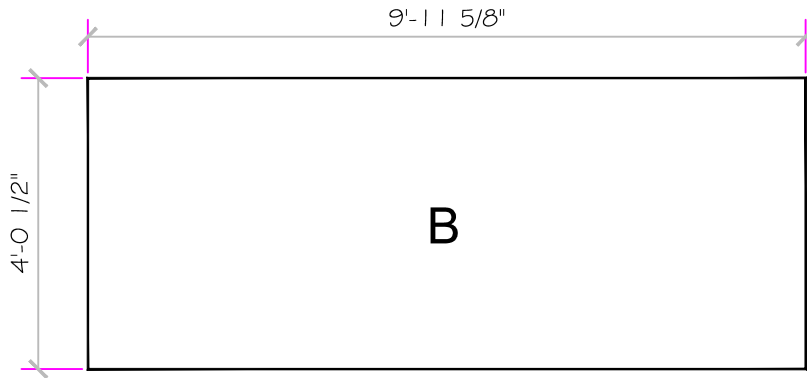
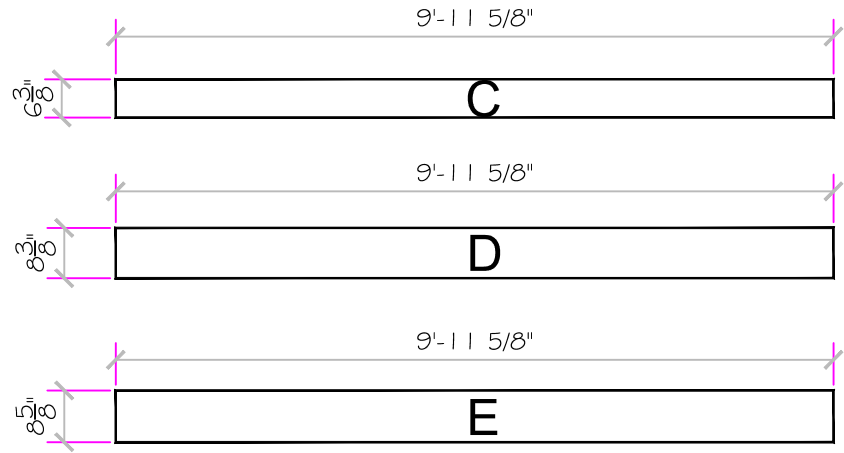
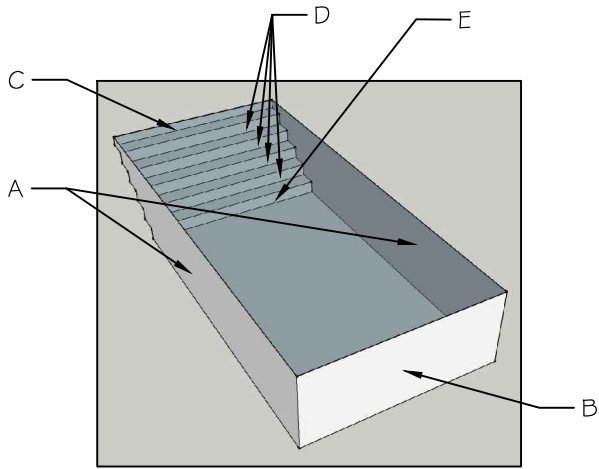

ALL DIMENSIONS SUBJECT TO 1/4" TOLERANCES

These drawings, concepts, and details contained herein are the original proprietary designs of **MAINLINE Com Pools, Inc.**, developed over many years of experience in the industry and as such are protected by the copyright laws of the United States Government. Reproduction of any of the above without written permission to do so by **MAINLINE Com Pools, Inc.** is illegal.

MAINLINE - Commercial Pools, Inc.
 441 Fehely Dr. King of Prussia, PA 19406
 Phone: (610) 279-9285 Fax: (610) 277-4276
 E-Mail: info@mainlinepools.com

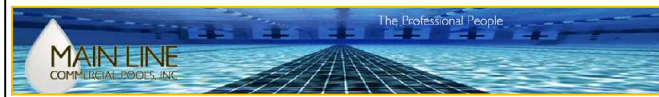

SCALE	DWG TYPE	
3/8" = 1'	Pool Table Set	
DWG NAME	DATE	SHEET
GOLD TEX	7/6/2012	1 OF 1

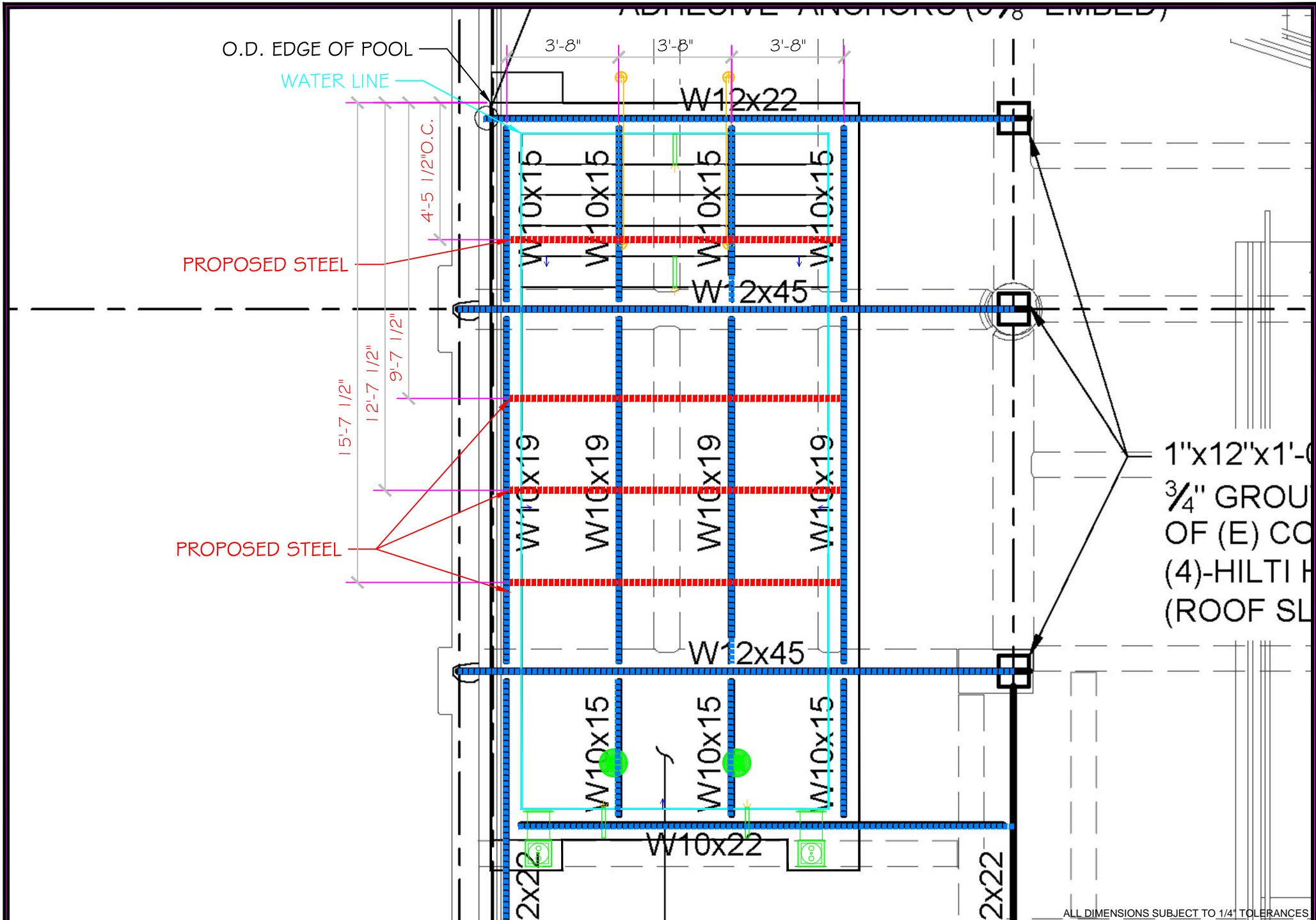

1"x12"x1'-0"
 3/4" GROUP
 OF (E) CO
 (4)-HILTI H
 (ROOF SL

ALL DIMENSIONS SUBJECT TO 1/4" TOLERANCES

These drawings, concepts, and details contained herein are the original proprietary designs of MAINLINE Com Pools, Inc., developed over many years of experience in the industry and as such are protected by the copyright laws of the United States Government. Reproduction of any of the above without written permission to do so by MAINLINE Com Pools, Inc. is illegal.

MAINLINE - Commercial Pools, Inc.
 441 Fehely Dr. King of Prussia, PA 19406
 Phone: (610) 279-9285 Fax: (610) 277-4276
 E-Mail: info@mainlinepools.com



SCALE 1/4" = 1'	DWG TYPE Proposed Pool Steel	
DWG NAME GOLD TEX	DATE 9/25/2012	SHEET 1 OF 1

O.D. EDGE OF POOL

WATER LINE

PROPOSED STEEL

1 1/4"
2'-7 1/4"
2'-7 1/4"
2'-7 1/4"
2'-7 1/4"
2'-7 1/4"

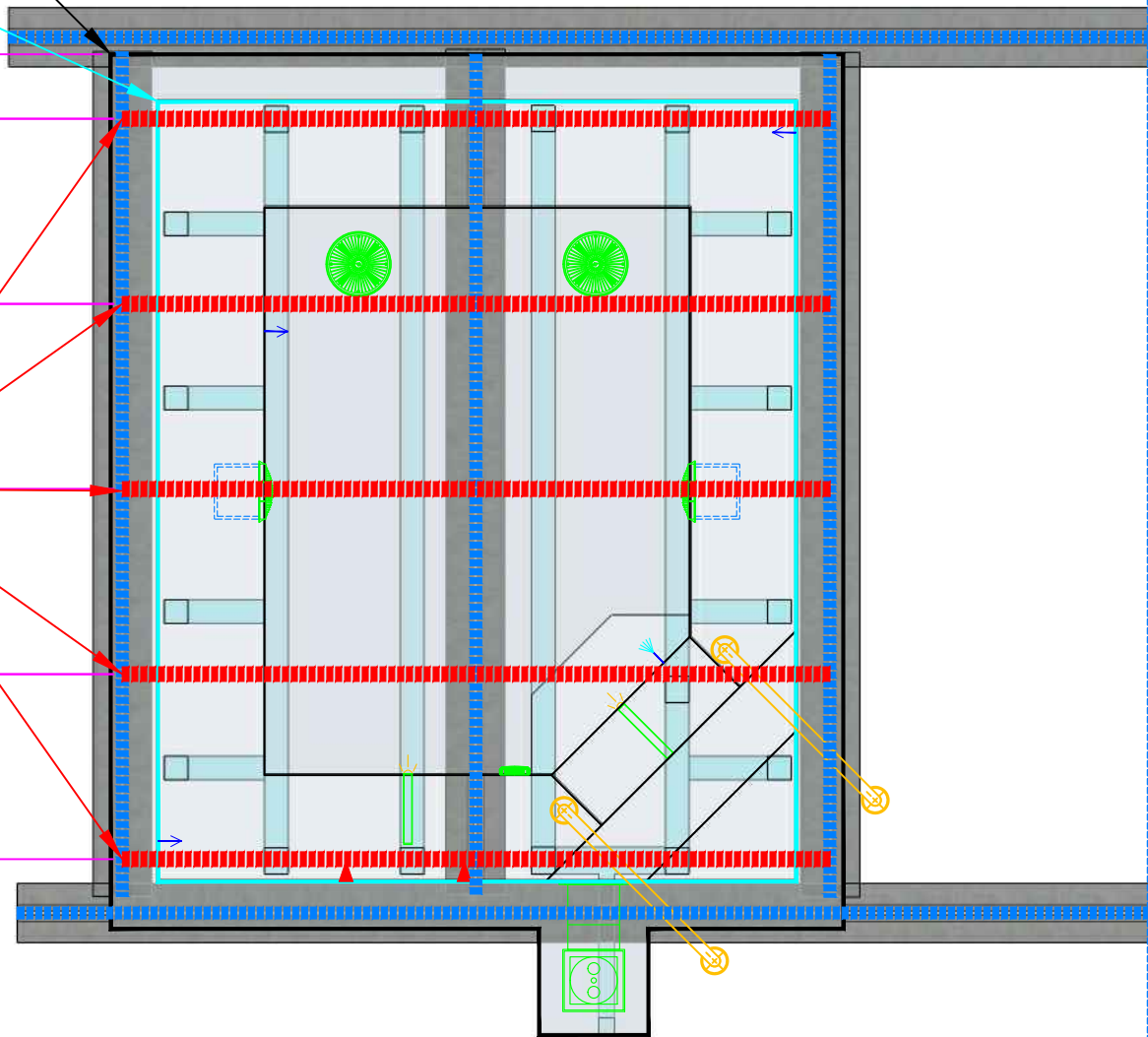

ALL DIMENSIONS SUBJECT TO 1/4" TOLERANCES

These drawings, concepts, and details contained herein are the original proprietary designs of **MAINLINE Com Pools, Inc.**, developed over many years of experience in the industry and as such are protected by the copyright laws of the United States Government. Reproduction of any of the above without written permission to do so by **MAINLINE Com Pools, Inc.** is illegal.

MAINLINE - Commercial Pools, Inc.
 441 Fehelley Dr. King of Prussia, PA 19406
 Phone: (610) 279-9285 Fax: (610) 277-4276
 E-Mail: info@mainlinepools.com



SCALE	DWG TYPE	
3/8" = 1'	Proposed Spa Steel	
DWG NAME	DATE	SHEET
GOLD TEX	9/25/2012	1 OF 1

STANDARD NESPA IN-GROUND INSTALLATION INSTRUCTIONS **SET-UP AND EXCAVATION**

Prerequisites: Before installing your Nespa spa. You may be required to acquire a permit from your local State, County, and City building dept and or Health department. (Commercial jobs need Health Dept. Approval). Your spa installation must comply with the most current codes. (**Uniform Swimming Pool, Spas & Hot Tub Code 2006 (USPC 2006)**).

Spa drawings: Request from Nespa a current spa specific construction detail, plan and section, spa plumbing detail.

Delivery Access: Clearly determine the method of getting the spa to jobsite and into the hole. This may require the use of a crane, forklift, hoist, backhoe and/or manpower etc.

- 1) The following instructions are general guidelines and may not apply to your specific jobsite conditions. When excavating for your spa remember to provide for plumbing and light connection clearances. In order to determine how to excavate for your spa or swim spa, measure spas outside dimension (O.D.) and add minimum 3” to all sides. This 3” clearance is to accommodate jet and suction plumbing. This 3” clearance can change or be reduced upon request. Note: skimmer location, this area may have to be larger than 3”, if commercial 22”.
- 2) **Freeze Climates-** If the spa is place into a vault (typical of freeze climates) a standard 18” or more of clearance minimum from spa perimeter should be provided. This dead air space is for possible future access to spa plumbing in case of a freeze. Area drain is mandatory. **Ask your local installer** for his experienced opinion. Do not hesitate to call us because we want to be sure that your installation progresses as smoothly as possible. If you have questions call us. (888) 479-4677.
- 2) **Hole depth** is determined by spa’s outside height dimension. This height may vary depending if spa has skids or no skids. The spa lip may be finished or non- finished. How is the perimeter deck elevation transitioning to the spa? Focus on the finish surrounding deck elevations, thickness of the finish material on spa upper horizontal lip, equal to lip or under the spa lip. This material can be tile, stone, concrete or brick.
- 3) **Preplumb** the spa before it goes into the hole. If there are needs for electrical , bonding or control conduits run them as well before dropping in hole. Connect bond wire to niche would be best.
- 4) **Spa should sit on level 3 ½” thick reinforced concrete pad. Sweep debris off pad prior to dropping in hole.**
- 5) **Install spa** into the hole on top of concrete pad. Use the Eye bolts provided for crane, forklift etc. rigging. Do not hold onto pipes. Use caution with suction and jet plumbing when lowering into hole. **DO NOT STRESS FITTINGS!** Fill Spa with water and check for leaks prior to backfill.

- 6) **Check site reference** points for proper spa positioning (i.e., squaring to house, garage, etc.).
- 7) **Shim to level spa.** Shim with non-compression able material. Re square to house, or ref. point.
- 8) **Dry pack** with cement the gaps that have been created when shimming spa level.
- 9) **Connect pipes to tees** if spa is preplumb. Installers properly support your new plumbing from stressing spas preplumb fittings. After electrical conduit and bond wire is connected to light niche, water test spa before back filling with sand.
NOTE: All Nespa products are water tested prior to leaving factory.

ELECTRICAL:

- 1) All electrical connections to spa or equipment should comply with the most recent national electrical code (NEC), state and local codes.
- 2) Connect electrical conduit to light niche. This work should be done or reviewed by a licensed electrician.
- 3) To install spa light you will need to include inside the PVC conduit to the light niche a solid #8 coated copper wire. (If you are use brass conduit, internal bond wire is not required.) This bond wire should be pulled with the light cord at the same time. This bond wire needs to be attached to the internal bonding lug of the light niche. An approved encapsulate should be applied to bond wire connection in niche.
- 4) An external #8 copper wire shall be connected to the external bonding lug on the rear of the light niche. This copper wire can then be used for additional bonding requirements (i.e., handrails or any other metallic object within 5' of the spa.

PLUMBING:

- 1) **When plumbing a Nespa it is important to properly size the plumbing. We highly recommend that you follow the pump manufacturer's pipe sizing requirements and Uniform Swimming Pool, Spas & Hot Tub Code 2006 (USPC 2006). This code book is available at www.IAPMO.org or (909) 472 4100.**
- 2) The jet air venturi should be a Hartford loop design adjacent to spa shell and air entry point can be located next to spa or remotely at equipment.
- 3) Fill spa with water and test the system for leaks PRIOR to backfilling with sand.

SAND BACK FILL:

- 1) **With water in spa, back-fill around spa perimeter with dry plaster sand and wet wash with hydraulic attachment to hose. Let set for one hour and hydraulic dry again. Be sure water level in spa is at the highest level. Any questions please call us. (888) 479-4677.**
- 2) **If spa is free standing on elevated deck or a structure, it is important to fill spa with water and load area prior to installing coping or perimeter decking. If spa is installed in a vault situation a area drain is needed.**

NESPA ENTERPRISES INC.

2800 Richter Ave. Suite E

Oroville, CA 95966

Office: (888) 479-4677 Fax: (530) 534-9915

E-Mail: nespa@pacbell.net www.tiledspas.com

IN-GROUND

INSTALLATION

ALL DIMENSIONS SUBJECT TO 1/4" TOLERANCES

SCALE: 1/2" = 1'-0"

DATE: 3/27/02

JOB : STANDARD INSTALL

DW #: SI-1, SI-2

NOTE:

Sump pump or gravity drain is required for removing water from vault

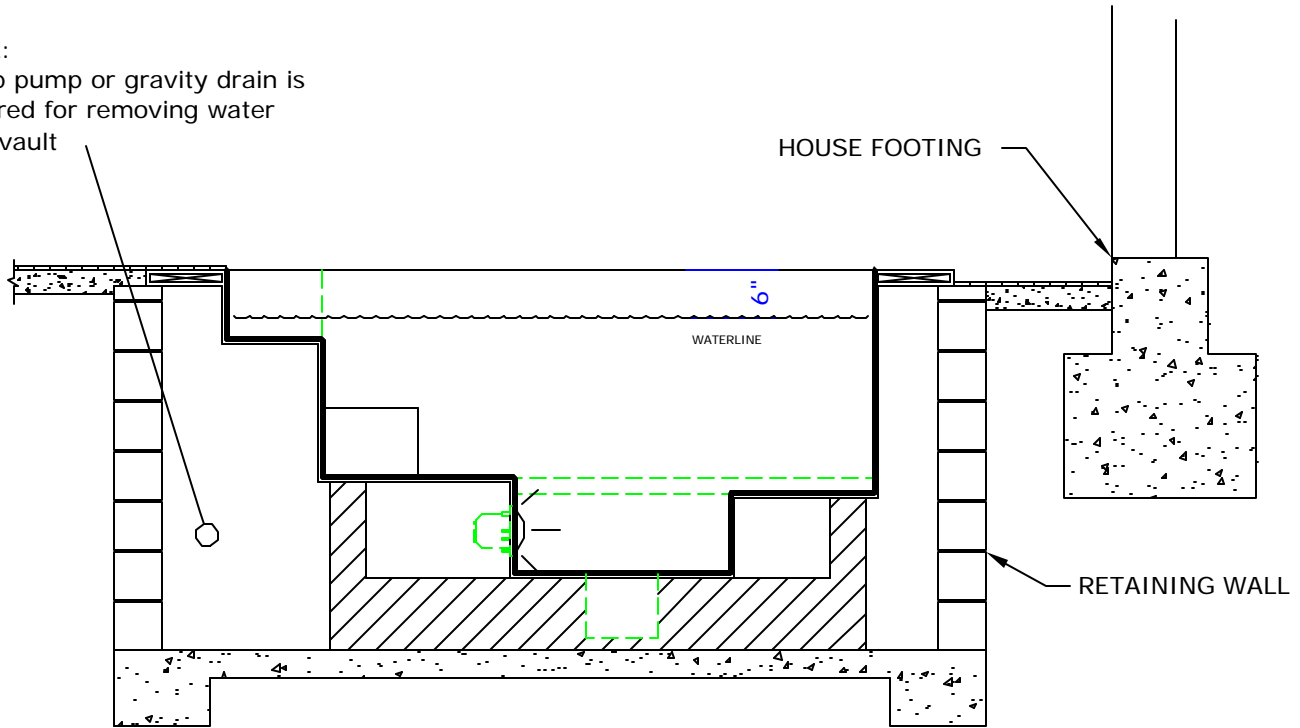

STANDARD VAULT INSTALLATION

SI-1

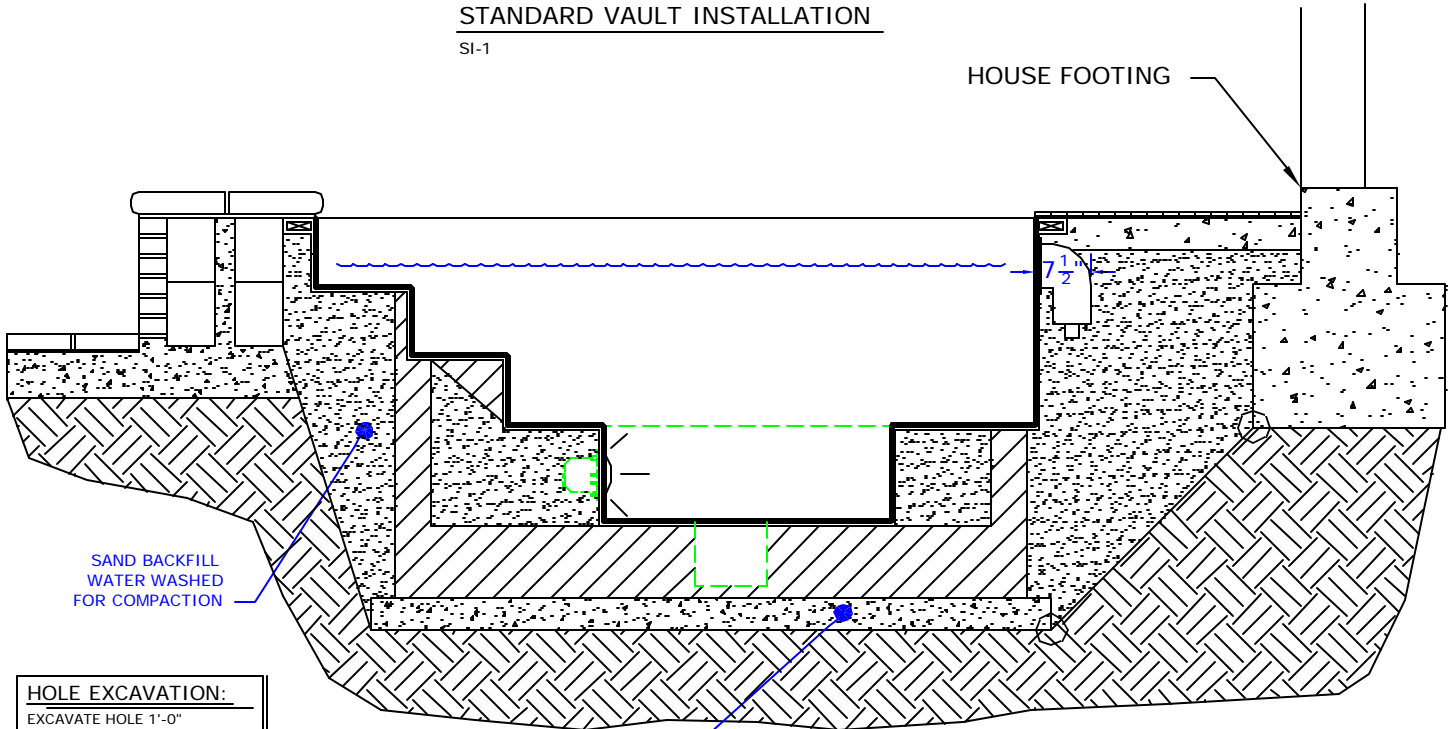

SAND BACKFILL
WATER WASHED
FOR COMPACTION

HOLE EXCAVATION:
EXCAVATE HOLE 1'-0"
LARGER THAN THE OUTSIDE
DIAMETER (OD) OF SPA

4" CONCRETE SLAB
REINFORCED WITH
#10 MESH

STANDARD INGROUND INSTALLATION

SI-2

NOTE:

Footing can not surcharge spa.
Slope from bottom of slab to
nearest corner of house footing
must not exceed 1" = 1".

POOL BONDING REQUIREMENTS:

1. THE FOLLOWING PARTS SHALL BE BONDED TOGETHER AND CONNECTED TO THE COMMON BONDING GRID.
 - A. ALL THE METALLIC PARTS OF THE POOL STRUCTURE INCLUDING COPING STONES, DECK, PERMANENT PLAY STRUCTURES, PERMANENT EXERCISE STRUCTURES.
 - B. ALL METAL FITTINGS WITHIN OR ATTACHED TO THE POOL STRUCTURE
 - C. METAL PARTS ASSOCIATED WITH THE POOL WATER CIRCULATING SYSTEM, INCLUDING PUMPS, FILTERS, AND HEATERS.
 - D. METAL PARTS ASSOCIATED WITH POOL COVERS
 - E. METAL SHEATHED CABLES AND RACEWAYS, METAL PIPING AND ALL FIXED METAL PARTS WITHIN 5 FEET HORIZONTALLY OF INSIDE WALLS OF POOL AND WITHIN 12 FEET ABOVE MAXIMUM WATER LEVEL OF POOL.
 - F. METAL PARTS ASSOCIATED WITH OBSERVATION STANDS, TOWERS, PLATFORMS, AND DIVING STRUCTURES.
2. BONDING CONDUCTORS SHALL BE MINIMUM #8 SOLID COPPER, INSULATED E.C. SHALL COORDINATE APPROVED CONNECTOR TYPE AND METHOD WITH LOCAL ELECTRICAL AND/ OR POOL INSPECTOR.
3. SPECIFIC MANUFACTURER'S INSTRUCTIONS REGARDING BONDING OR GROUNDING OF POOL EQUIPMENT, WHETHER INDICATED HEREIN OR NOT, SHALL BE STRICTLY FOLLOWED.
4. THE COMMON BONDING GRID SHALL NOT BE CONNECTED TO ANY ELECTRICAL DISTRIBUTION EQUIPMENT.
5. ANY PARTS IN ADDITION TO THOSE DESCRIBED HEREIN THAT ARE INDICATED BY POOL CONTRACTOR OR LOCAL INSPECTION AUTHORITY SHALL BE BONDED TO THE COMMON BONDING GRID WITH NO ADDITIONAL COSTS INCURRED BY THE OWNER.
6. THE ELECTRICAL CONTRACTOR SHALL COORDINATE BONDING WITH GENERAL CONTRACTOR.

LIGHT DETAIL

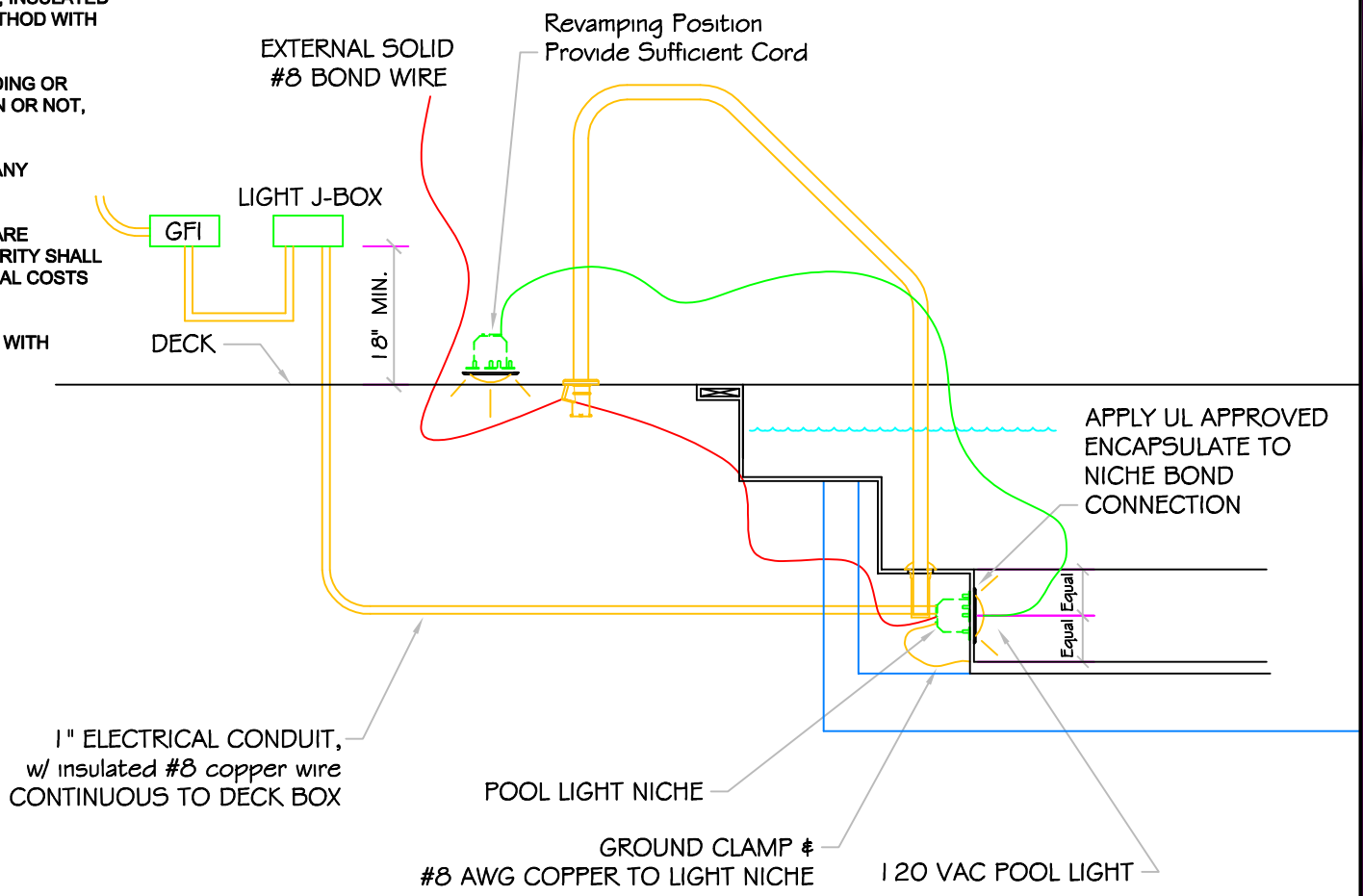

ALL DIMENSIONS SUBJECT TO 1/4" TOLERANCES

These drawings, concepts, and details contained herein are the original proprietary designs of NESPA ENTERPRISES, developed over many years of experience in the pool and spa industry and as such are protected by the copyright laws of the United States Government. Reproduction of any of the above without written permission to do so by NESPA ENTERPRISES, is illegal.

NESPA ENTERPRISES INC.
 2800 Richter Ave. Ste. C Oroville, CA 95966
 Office: (530) 534-9910 Fax: (530) 534-9915
 E-Mail: sales@tiledspas.com Web Site: www.tiledspas.com



SIZE A	DWG NAME DETAILS	DWG TYPE Detail
SCALE 1/2" = 1'	DATE 7/24/2008	SHEET PAGE 1 OF 1

NESPA ENTERPRISES, Inc. LIMITED WARRANTY

This LIMITED WARRANTY covering NESPA products is extended to the ORIGINAL PURCHASER-USER BY NESPA ENTERPRISES Inc.(NESPA), 2800 Richter Ave. Unit C California 95966.

NESPA products are thoroughly inspected and tested prior to factory shipment. NESPA warrants to the ORIGINAL PURCHASER-USER that NESPA Spas and Swim Spas will be free of defect in workmanship, accessories and parts, provided said accessories and parts were manufactured by NESPA. NESPA, under this LIMITED WARRANTY, warrants only that its Spas and Swim Spas shall be structurally sound, shall retain their shape, and shall retain water for the warranty period. NESPA warrants the adhesion of tile to fiberglass for a period of three (3) years and structural soundness for ten (10) years. NESPA warrants epoxy grout adhesion for a period of three years. If any such defects appear and are reported within the warranty period, NESPA shall repair or replace such defective parts without charge if an inspection proves the claim.

The provisions of the LIMITED WARRANTY shall not apply to tile cracked, split, chipped or damaged after the product has left the factory, nor damage to tile caused by freezing nor to damage, defect, malfunction or failure to conform with the above warranty provisions where the damage, defect, malfunction or failure to conform was caused during shipment or by distributor or by unreasonable use by ORIGINAL PURCHASER-USER including improper water balance and improper sand pack or support.

This LIMITED WARRANTY shall not apply to any plumbing, equipment, or installation of spas and Swim Spas and shall not apply to any alterations made to or upon NESPA products except alterations made by NESPA employees or NESPA authorized representatives.

This LIMITED WARRANTY is expressly in lieu of all other warranties expressed or implied including the warranties of merchantability and fitness for use and all other obligations or liabilities on NESPA'S part, and NESPA neither assumes nor authorizes any other person to assume for NESPA any other liability in connection with the sale of this NESPA product. This LIMITED WARRANTY shall not apply to this NESPA product or any part thereof which has been subject to accident, negligence, alteration, abuse or misuse. NESPA makes no warranty whatsoever with respect to accessories or parts not manufactured by NESPA.

The term "ORIGINAL PURCHASER-USER" as used in this LIMITED WARRANTY shall be deemed to mean that person for whom the NESPA product is originally installed.

The LIMITED WARRANTY provided herein and the obligations and liabilities of NESPA hereunder are exclusive and are in lieu of, and buyer and original PURCHASE-USER hereby waive all other remedies, warranties, guarantees or liabilities, expressed or implied, arising by law or otherwise (including without limitation and obligations of NESPA with respect to fitness, merchantability, and consequential damages) or whether or not occasioned by NESPA'S negligence.

This LIMITED WARRANTY shall not be extended, altered or varied except by a written instrument signed by NESPA and original PURCHASER-USER.