

NESPA ENTERPRISES INC.

2800 Richter Ave, Suite C
 Oroville, CA 95966
 Office: (530) 534-9910 Fax: (530) 534-9915
 E-Mail: sales@tiledspas.com www.tiledspas.com

CUSTOM

SPA DETAIL

ALL DIMENSIONS SUBJECT TO 1/4" TOLERANCES

SCALE: 1/2" = 1'-0"

DATE: 9/01/04

JOB: WESTERN EQUITIES

DR#: WEQ-CST-SD04

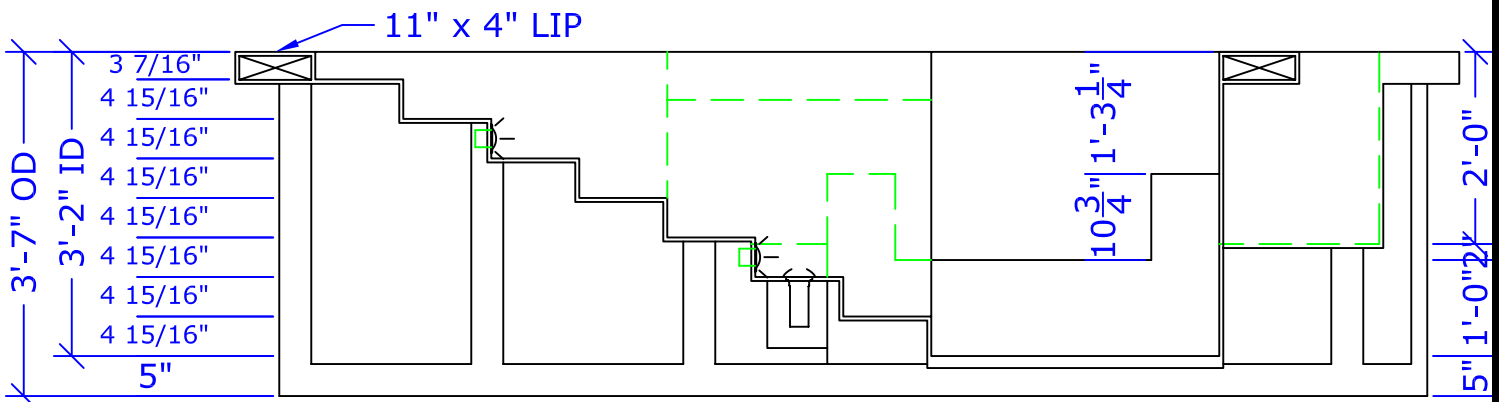
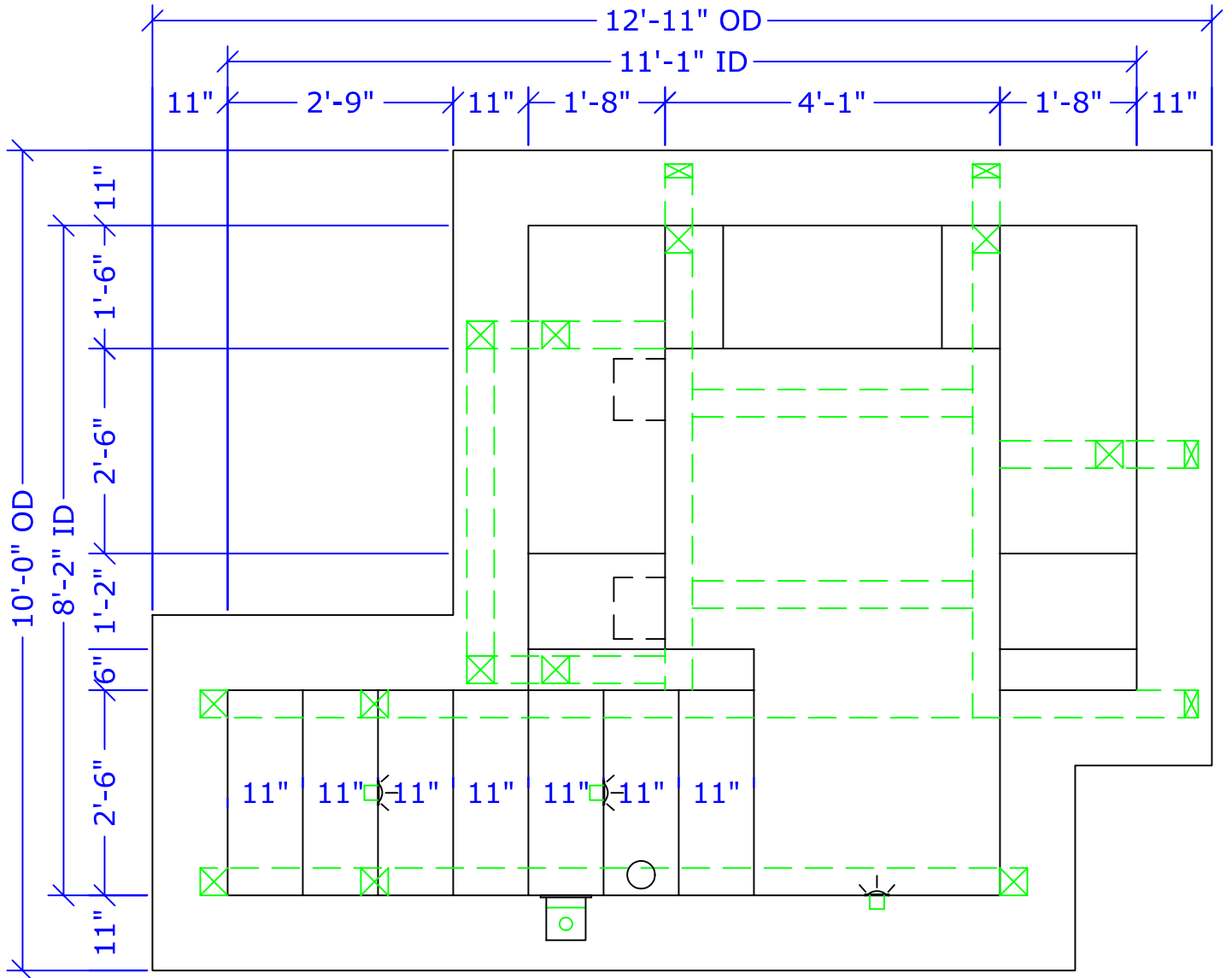

NESPA ENTERPRISES INC.

2800 Richter Ave. Suite C

Oroville, CA 95966

Office: (530) 534-9910 Fax: (530) 534-9915

E-Mail: sales@tiledspas.com www.tiledspas.com

CUSTOM

SCALE: 1/2" = 1'-0"

DATE: 9/01/04

SUCTION PLUMBING

JOB: WESTERN EQUITIES

DR#: WEQ-CST-SP01

ALL DIMENSIONS SUBJECT TO 1/4" TOLERANCES

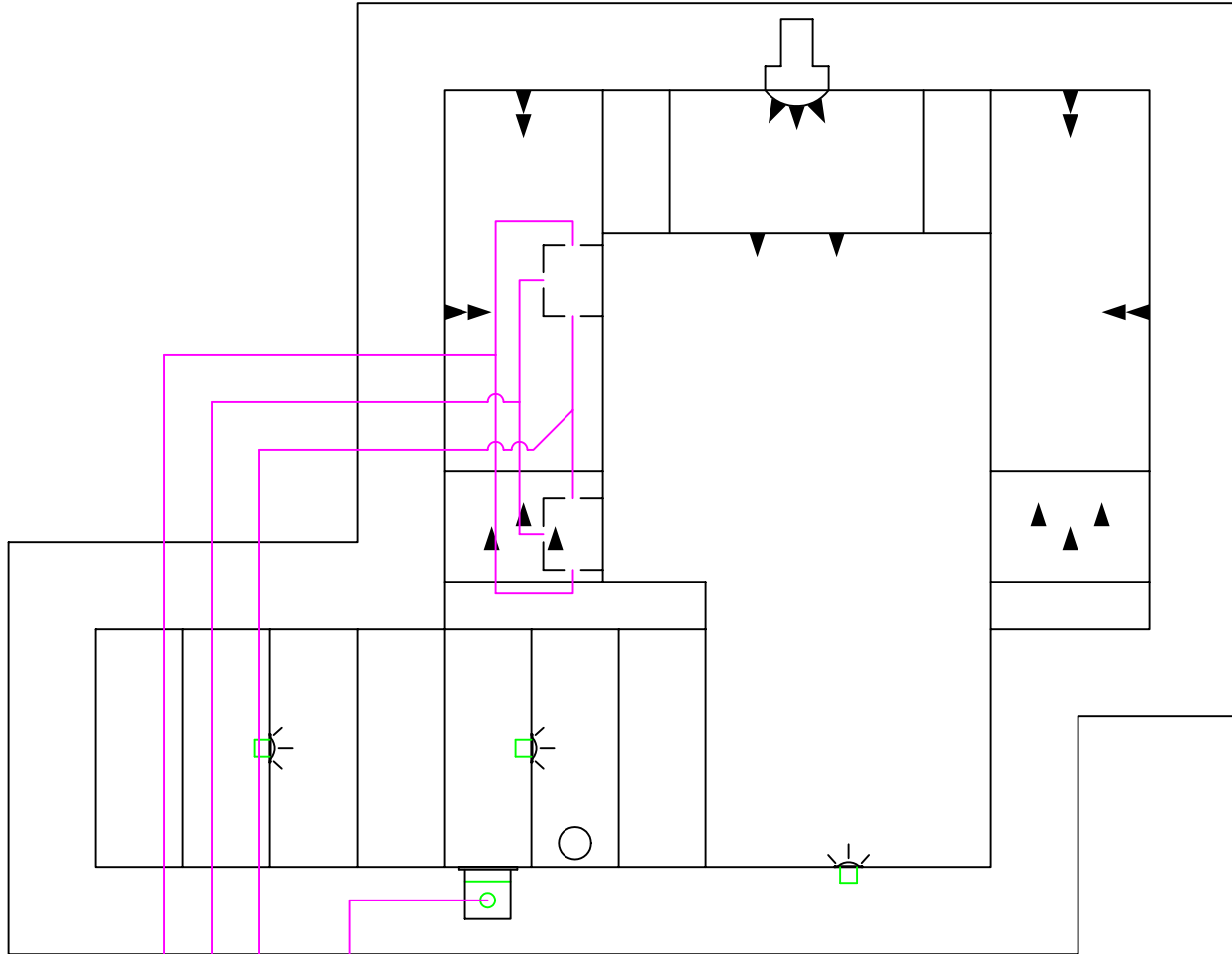

3" BOOSTER SUCTION A

3" BOOSTER SUCTION B

2 1/2" FILTER SUCTION

1 1/2" SKIMMER SUCTION

NESPA ENTERPRISES INC.

2800 Richter Ave. Suite C

Oroville, CA 95966

Office: (530) 534-9910 Fax: (530) 534-9915

E-Mail: sales@tiledspas.com www.tiledspas.com

CUSTOM

SCALE: 3/8" = 1'-0"

DATE: 9/01/04

BOOSTER PLUMBING

JOB: WESTERN EQUITIES

DR#: WEQ-CST-BP01

ALL DIMENSIONS SUBJECT TO 1/4" TOLERANCES

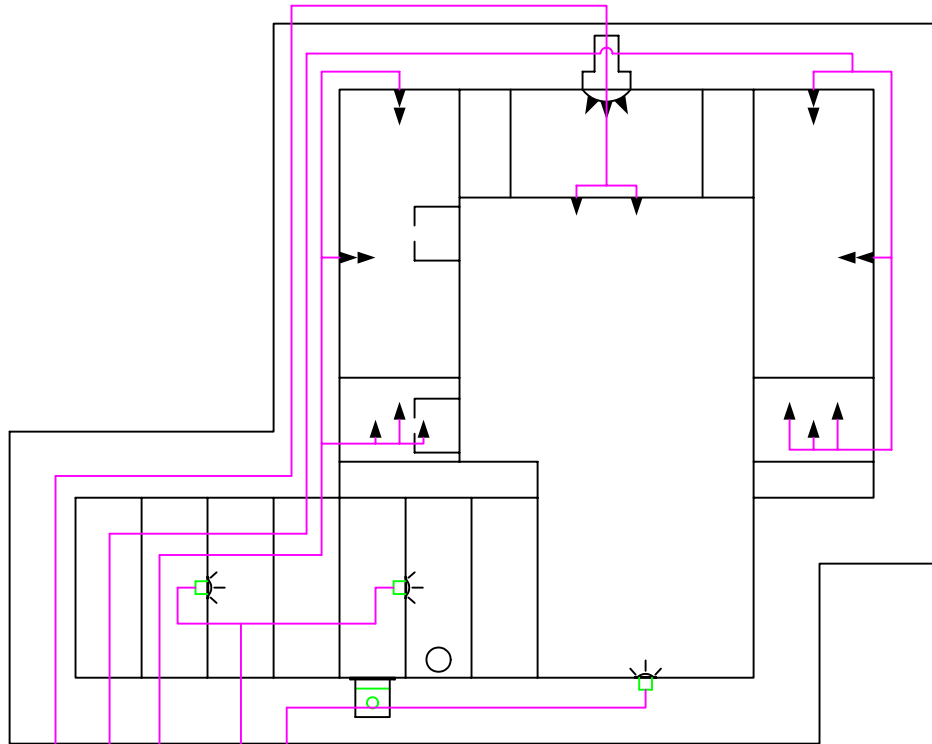

2 1/2" FILTER RETURN WITH 1 1/2" AIR VENTURI

2 1/2" BOOSTER RETURN A WITH 1 1/2" AIR VENTURI

2 1/2" BOOSTER RETURN B WITH 1 1/2" AIR VENTURI

LOW VOLTAGE LIGHT CONDUIT

LOW VOLTAGE LIGHT CONDUIT

NESPA ENTERPRISES INC.

2800 Richter Ave, Suite C
Oroville, CA 95966
Office: (530) 534-9910 Fax: (530) 534-9915
E-Mail: sales@tiledspas.com www.tiledspas.com

CUSTOM

VAULT DETAIL

ALL DIMENSIONS SUBJECT TO 1/4" TOLERANCES

SCALE: 1/2" = 1'-0"

DATE: 9/01/04

JOB: WESTERN EQUITIES

DR#: WEQ-CST-VD06

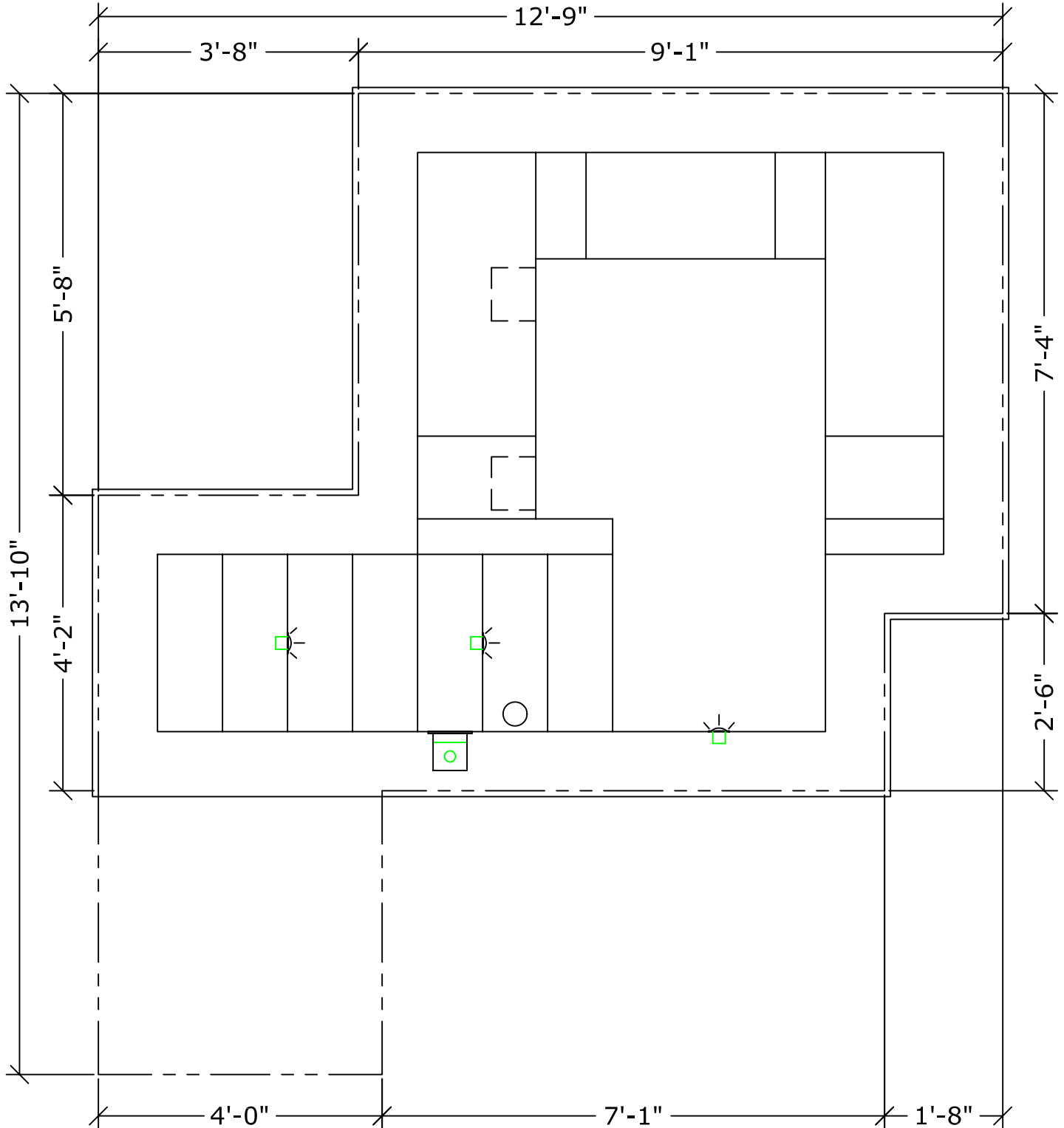

NESPA ENTERPRISES INC.

2800 Richter Ave, Suite C

Oroville, CA 95966

Office: (530) 534-9910 Fax: (530) 534-9915

E-Mail: sales@tiledspas.com www.tiledspas.com

CUSTOM

EQUIPMENT LAYOUT

ALL DIMENSIONS SUBJECT TO 1/4" TOLERANCES

SCALE: 1/2" = 1'-0"

DATE: 5/06/04

JOB: WESTERN EQUITIES

DR#: WEQ-CST-EQL04

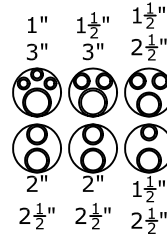
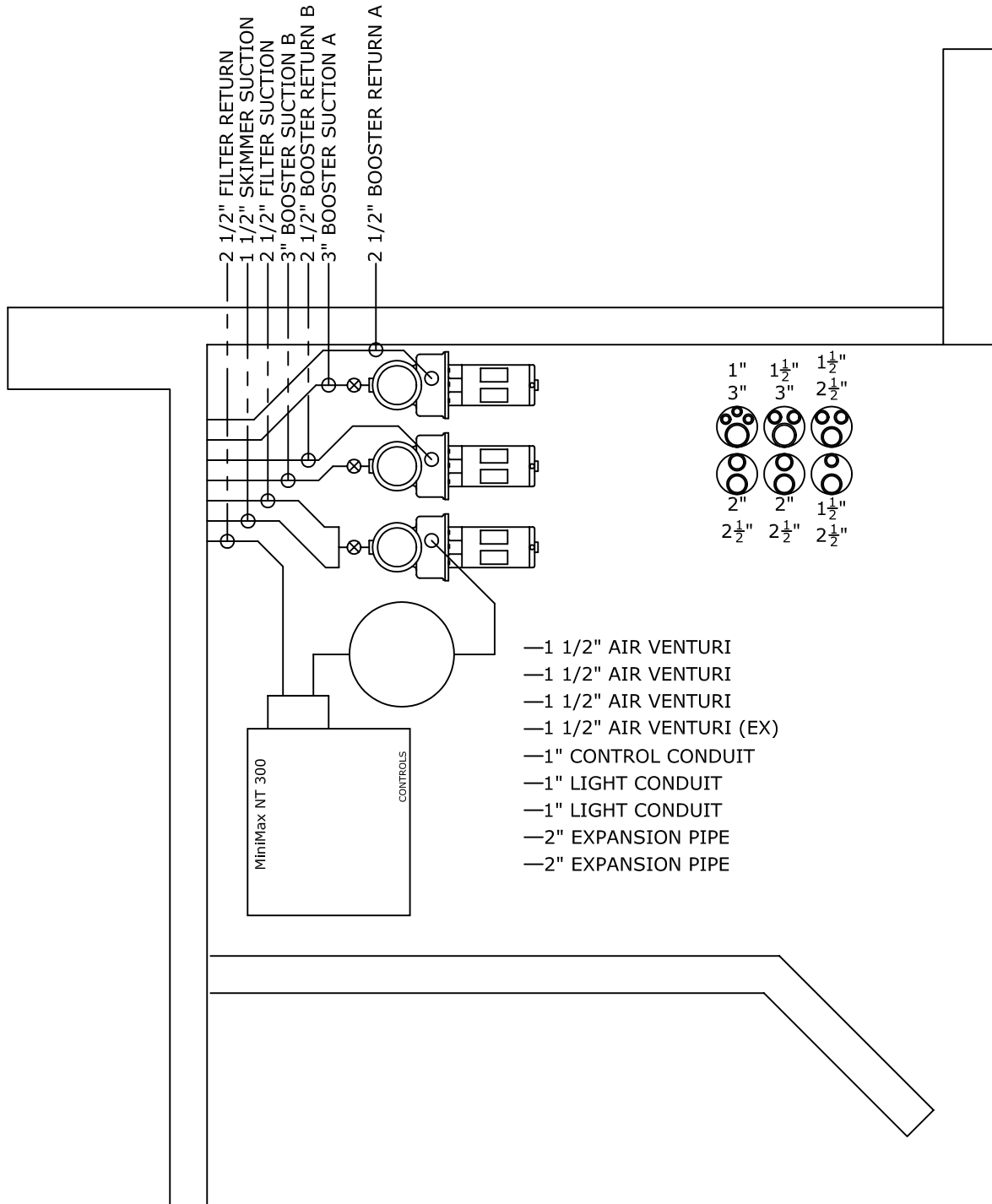

- 1 1/2" AIR VENTURI
- 1 1/2" AIR VENTURI
- 1 1/2" AIR VENTURI
- 1 1/2" AIR VENTURI (EX)
- 1" CONTROL CONDUIT
- 1" LIGHT CONDUIT
- 1" LIGHT CONDUIT
- 2" EXPANSION PIPE
- 2" EXPANSION PIPE

NESPA ENTERPRISES INC.

2800 Richter Ave. Suite C
Oroville, CA 95966

Office: (530) 534-9910 Fax: (530) 534-9915

E-Mail: sales@tiledspas.com www.tiledspas.com

CUSTOM

VAULT LAYOUT

ALL DIMENSIONS SUBJECT TO 1/4" TOLERANCES

SCALE: 3/16" = 1'-0"

DATE: 5/05/04

JOB: WESTERN EQUITIES

DR#: WEQ-CST-VL01

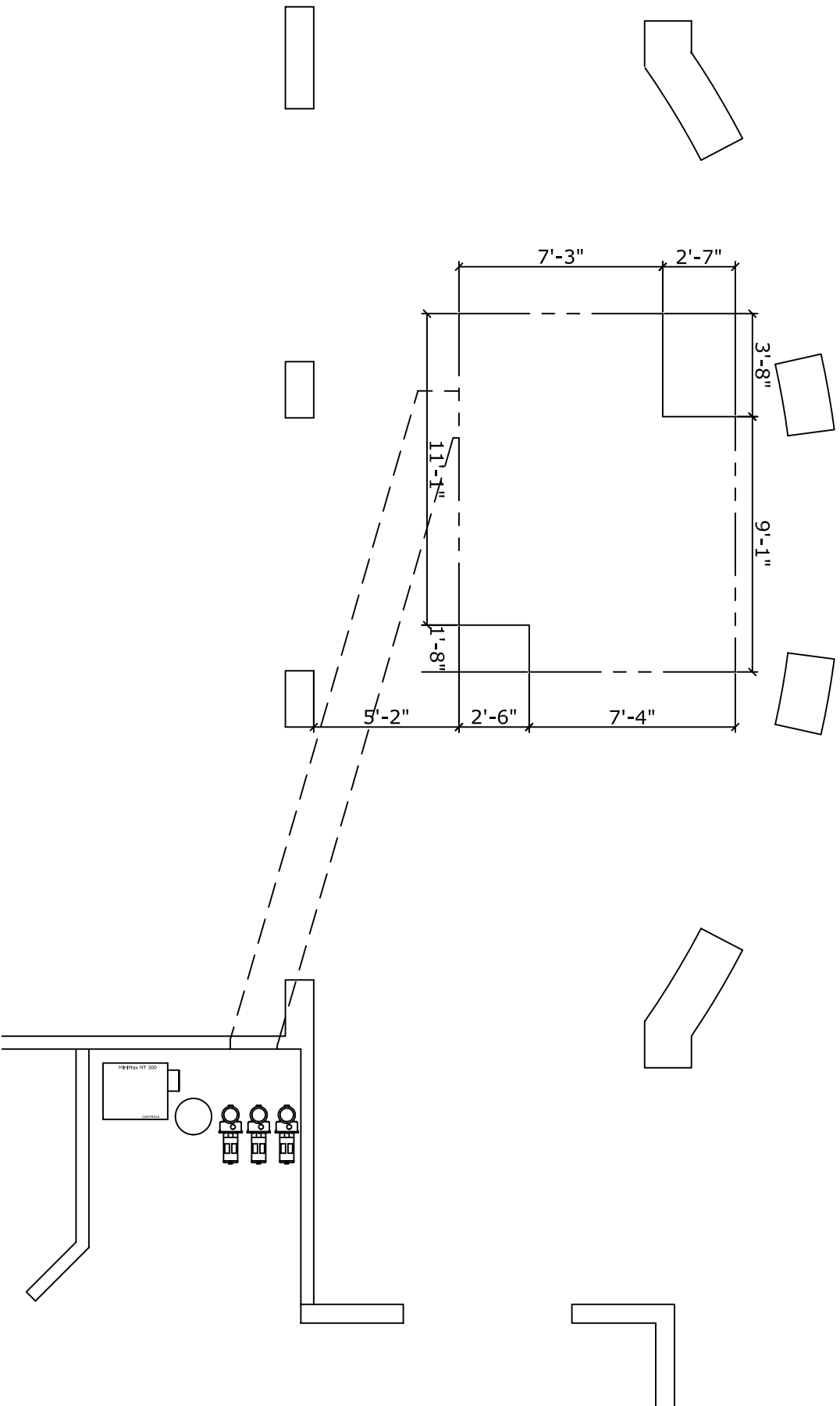

These drawings, concepts, and details contained herein are the original proprietary designs of NESPA ENTERPRISES, developed over many years of experience in the pool and spa industry and as such are protected by the copyright laws of the United States Government. Reproduction of any of the above without written permission to do so by NESPA ENTERPRISES, is illegal.

NESPA ENTERPRISES INC.

2800 Richter Ave. Suite C
Oroville, CA 95966

Office: (530) 534-9910 Fax: (530) 534-9915

E-Mail: sales@tiledspas.com www.tiledspas.com

CUSTOM

SPA LAYOUT

ALL DIMENSIONS SUBJECT TO 1/4" TOLERANCES

SCALE: 3/16" = 1'-0"

DATE: 5/05/04

JOB: WESTERN EQUITIES

DR#: WEQ-CST-VL01

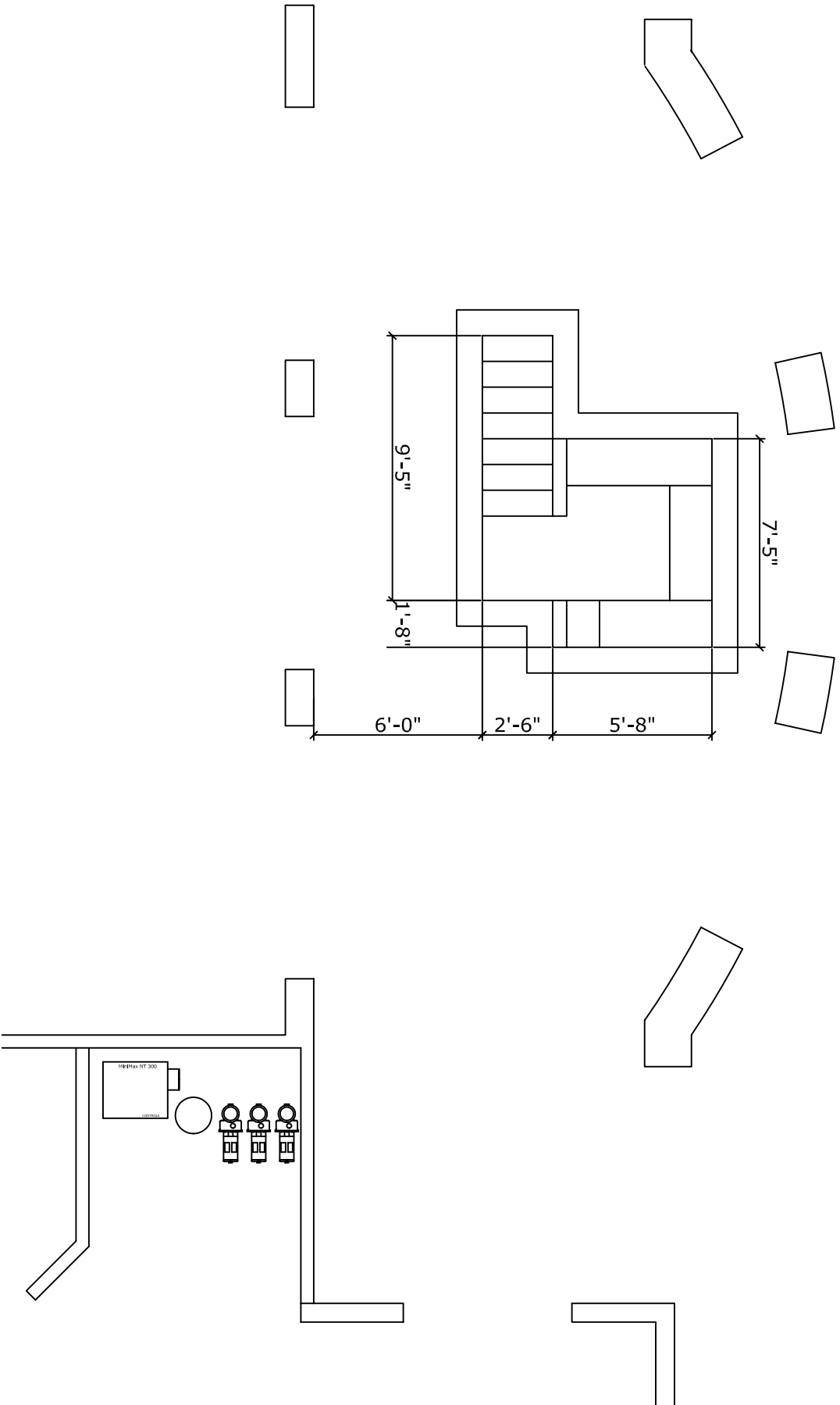

These drawings, concepts, and details contained herein are the original proprietary designs of NESPA ENTERPRISES, developed over many years of experience in the pool and spa industry and as such are protected by the copyright laws of the United States Government. Reproduction of any of the above without written permission to do so by NESPA ENTERPRISES, is illegal.